



EXMAS
INTERNATIONAL

EXMAS INTERNATIONAL SOLUTIONS LTD.

➤ **Location:**

Landmark Plaza, Argwings Kodhek Rd, Nairobi

➤ **Company Registration NO:**

REF NO: PVT-BEUEBD5V

➤ **Company KRA Pin**

P052352851B

➤ **Phone No:**

+254714073647 or +254725415177

➤ **Email address**

info@exmasinternationalsolutions.com
director@exmasinternationalsolutions.com

➤ **website**

www.exmasinternationalsolutions.com

Square D QO[®] Loadcentres and Circuit Breakers Selection Guide

Contents	Description	Page
General Information		
	• Product Illustrations/Features	3-4
QO[®] Breakers		
	• QO [®] Standard Breakers and Tandem Circuit Breakers.	5
	• QO [®] Special Breakers (QO-CAFI, QO-DF, QO-GFI, QO-EPD, QO-HID, QO-AFI, QO-K, and QO-HM)	6
	• Circuit Breaker Factory Installed Accessories	7
	• Circuit Breaker Wire Sizes	7
QO[®] Loadcentres		
	• QO [®] Main Lugs Loadcentres - Type 1 Indoor	8
	• QO [®] 'Stand Alone' Generator Panels	8
	• QO [®] Combination SE 'all-in-one' Generator Panels	8
	• QO [®] Main Breaker Loadcentres - Type 1 Indoor	9
	• QO [®] Main Lugs/Main Breaker Loadcentres - Type 3R Weatherproof	10
	• QO [®] Recreational Vehicle Park (ServicePak [®] Panels) and Mobile Home and Trailer Loadcentres	11
Accessories		
	• QO [®] Loadcentre and Circuit Breaker Accessories	12
	• QO [®] single phase loadcentre field installed neutral extension kits	13
	• Surge Protective Devices	14
Dimensional Information		
	• Enclosure Dimensions	15



General Information		
	• Product Illustrations / Features	17-20
	• Nomenclature Charts	21
HomeLine Breakers		
	• Standard and Main Circuit Breakers	22
	• Tandem and Quad Circuit Breakers	23
	• CAFI and DF	23
	• GFI, AFCI	24
	• Breaker Accessories	24
HomeLine Loadcentres		
	• Indoor Single Phase Main Lug & Main Circuit Breaker Loadcentres	25

Loadcentres and Circuit Breakers

- Type 3R Loadcentres and Type 1 Generator Panels 26
- HomeLine Fusible Loadcentre Inserts 27
- HomeLine Loadcentre Accessories 29

Technical Information

- Wiring Diagrams 32-33
 - Indoor Loadcentre Dimensions and Knockouts 34
 - Outdoor Loadcentre Dimensions and Knockouts 35
-

Federal Pioneer Stab-lok[®] Circuit Breakers Selection Guide

General Information

- Features and Benefits 37

Stab-lok[®] Replacement Circuit Breakers and Accessories

- Standard and Main Circuit Breakers 38
- Stab-lok Breaker Accessories 39
- Ground Fault Circuit Breakers and Spa Buddy 40
- Arc-Fault Circuit Interrupters and Stab-lok Generator Panel - Replacement Breakers 41

Stab-lok[®] Replacement RV Panel Receptacle Kits

- Recreational Vehicle Park Power Centre - Receptacle Kits 42

Stab-lok[®] Loadcentre Replacement Accessories

- Stab-lok Loadcentre Replacement Accessories 43-43
-

- Pages:**
- DE1-5 to DE1-14
- Application:**
- Residential, commercial, and industrial
 - 30 through 225 Amperes
- Standards:**
- CSA Certified under File #LL-89066
- Enclosures:**
- Type 1 and 3R
- Features:**
- Plug-on Neutral (Series S)
 - One piece, plated, shielded copper bus (Series S)
 - Split branch neutral with 3-1/0 "built in" branch neutral lugs
 - Combination Slot/Robertson neutral, ground and trim screws
 - Additional ground bar provisions
 - Trims have automatic flush adjustment
- Accessories:**
- Secondary Surge Arresters
 - Sub-Feed Lugs
 - Filler Plates (for branch and main breakers)
 - Door Lock Kits
 - Neutral Lugs
 - QO single phase neutral extension kits



QO[®] Loadcentres and Circuit Breakers

General Information

QO[®] Circuit Breaker

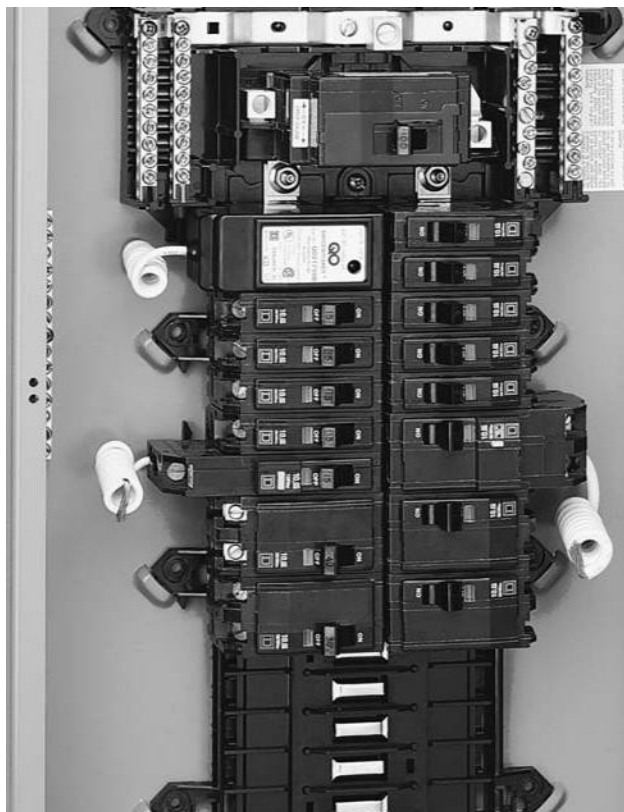

Branches: • QO-CAFI - Combination Arc Fault Circuit Interrupter

- QO-DF - Dual Function - CAFI+GFI (5mA)
- QO - Plug-On Circuit Breakers
- QO-GFI - Ground Fault Indication
- QOT - Tandem Breakers
- QO-EPD - Equipment Ground Fault Protection
- QO-HID - High Intensity Discharge Lighting Systems
- QO-K - Key Operated Breakers
- QO-AFI - ARC Fault Circuit Interrupters
- QO-HM - High Magnetics

- Features:**
- QWIK-OPEN[®] Circuit Breakers
 - VISI-TRIP[®] Indicator
 - Tandem Circuit Breakers feature two 1-Pole breakers in the space of a 1-Pole QO breaker
 - Shunt Trips, Auxiliary Switches, and Alarm Switches are all available factory installed

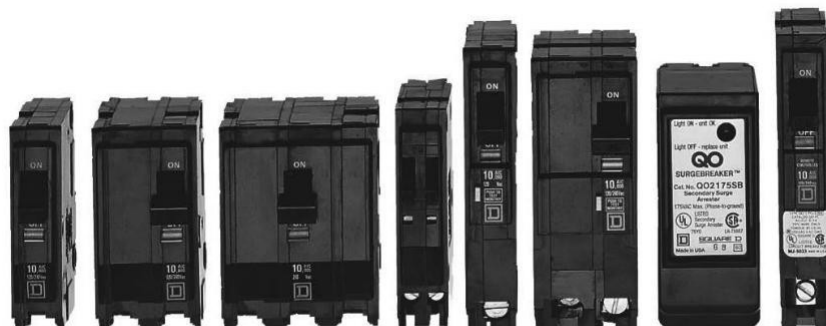

For additional information,

- QO & QOB Miniature Circuit Breakers Catalogue 0730CT9801R1/08.
- QO-EPD Catalogue 0950CT9601
- Square D Series Ratings Guide Catalogue D0110AB9801EP R0
- Secondary Surge Arresters Catalogue 6671CT9701R9/06

QO[®] Loadcentres and Circuit Breakers

QO[®] Standard and Tandem Circuit Breakers

DE1 LOAD CENTRES

Plug-On Circuit Breakers - Amperes Interrupting Rating (AIR) in Amperes RMS Symmetrical

Ampere Rating	One Pole - 120/240Vac	Two Pole - 120/240Vac Common Trip	Three Pole - 240Vac Common Trip
10,000 AIR			
10	QO110	QO210	QO310
15	QO115◆▲	QO215◆	QO315◆
15	QO115HM◆▲‡	—	—
20	QO120◆▲	QO220◆	QO320◆
20	QO120HM◆▲‡	—	—
25	QO125	QO225◆	QO325◆
30	QO130◆	QO230◆	QO330◆
35	QO135◆	QO235◆	QO335◆
40	QO140◆	QO240◆	QO340◆
45	QO145◆	QO245◆	QO345◆
50	QO150◆	QO250◆	QO350◆
60	QO160◆	QO260◆	QO360◆
70	QO170◆	QO270◆	QO370
80	—	QO280	QO380
90	—	QO290	QO390
100	—	QO2100	QO3100
110	—	QO2110	—
125	—	QO2125 No DC rating	—
150	—	QO2150◆▼	—
175	—	QO2175◆▼	—
200	—	QO2200◆▼	—
22,000 AIR			
15	QO115VH▲	QO215VH	QO315VH
20	QO120VH▲	QO220VH	QO320VH
25	QO125VH	QO225VH	QO325VH
30	QO130VH	QO230VH	QO330VH
40	—	QO240VH	QO340VH
50	—	QO250VH	QO350VH
60	—	QO260VH	QO360VH
70	—	QO270VH	QO370VH
80	—	QO280VH	QO380VH
90	—	QO290VH	QO390VH
100	—	QO2100VH	QO3100VH
110	—	QO2110VH	—
125	—	QO2125VH	—
150	—	QO2150VH□◆▼	—
175	—	QO2175VH□◆▼	—
200	—	QO2200VH□◆▼	—
42,000 AIR			
40	—	QOH240	—
45	—	QOH245	—
50	—	QOH250	—
60	—	QOH260	—
70	—	QOH270	—
80	—	QOH280	—
90	—	QOH290	—
100	—	QOH2100	—
110	—	QOH2110	—
125	—	QOH2125	—
65,000 AIR			
15	QH115▲	QH215	QH315
20	QH120▲	QH220	QH320
25	QH125	QH225	QH325
30	QH130	QH230	QH330

QO One Pole



1 Space Required

QO One Pole Tandem



1 Space Required

QO Two Pole



2 Spaces Required

QO Three Pole



3 Spaces Required

Tandem (Dual) Circuit Breakers 10,000 AIR

Ampere Rating	One Pole - 120/240Vac	Two Single Pole Individual Trip - 120/240Vac
	1 Space Required	2 Spaces Required
15&15	QO1515◆	Order Two QO1515 or QO2020 Circuit Breakers and Handle Tie Catalogue # QOTHT.
15&20	QO1520◆	
15&30	QO1530◆	
20&15	QO2015◆	
20&20	QO2020◆	
20&30	QO2030◆	
30&15	QO3015◆	
30&20	QO3020◆	
30&30	QO3030◆	

10-30 ampere breakers are suitable for use with 60°C or 75°C conductors. 35-125 ampere breakers are suitable for use with 75°C conductors.

‡ High magnetic trip breakers are recommended for applications where high initial inrush current may occur. ▲ SWD (switching duty) rated. Suitable for switching 120Vac fluorescent lighting loads.

◆ HACR type for use with air conditioning, heating and refrigeration equipment having motor group combinations and marked for use with HACR type circuit breakers. HACR labelled one pole QO breakers not stocked. Order Only. Add suffix -5385.

▼ Requires four spaces (#1-300 kcmil Al/Cu). Not suitable for use in 3-phase panel. Use only in single phase panel rated 150A or greater.

□ CSA Listed for use ahead of QO, QO-GFI, QO-EPD, QOT and QO-PL 10,000 AIR circuit breakers to permit their application at 22,000A fault level.

Application Information

- VISI-TRIP indication on all QO breakers.
- QO, VISI-TRIP and QWIK-GARD are registered trademarks of Square D.
- For more information consult Exmas International Solutions Electric.
- Accessories page DE1-11.
- Add suffix 35 for 50°C calibration - 20% price adder.

QO[®] Loadcentres and Circuit Breakers

QO[®] Special Breakers

Plug-On Circuit Breakers - Amperes Interrupting Rating (AIR) in Amperes RMS Symmetrical



One Pole QO-CAFI(PON) **One Pole QO-DF(PON)** **One Pole QO-GFI** **Two Pole QO-GFI**

QO-GFI QWIK-GARD[®] circuit breakers provide overload and short circuit protection, combined with Class A ground fault protection. Class A denotes a ground fault circuit interrupter that will trip when a fault current to ground is 6 milliamperes or more, for people protection. Do not connect to more than 250 feet of load conductor for the total one-way run to prevent nuisance tripping.

Ampere Rating	One Pole 120Vac		Two Pole-Common Trip 120/240Vac	Three Pole-Common Trip 120/240Vac
	10,000 AIR	22,000 AIR	10,000 AIR	10,000 AIR
15	QO115GFI	QO115VHGF	QO215GFI	QO315GFI
20	QO120GFI	QO120VHGF	QO220GFI	QO320GFI
25	QO125GFI	QO125VHGF	QO225GFI	—
30	QO130GFI	QO130VHGF	QO230GFI	QO330GFI
40	—	—	QO240GFI	QO340GFI
50	—	—	QO250GFI	QO350GFI
60	—	—	QO260GFI	—

❖ Suitable only for feeding 240Vac and 208Vac 2 wire loads. Does not contain load neutral connection.

QO-EPD QO Circuit Breakers With 30 mA Equipment Ground Fault Protection

Ampere Rating	One Pole 120Vac	Two Pole-Common Trip 120/240Vac
	10,000 AIR	10,000 AIR
15	QO115EPD	QO215EPD
20	QO120EPD	QO220EPD
25	QO125EPD	QO225EPD
30	QO130EPD	QO230EPD
40	—	QO240EPD
50	—	QO250EPD
60	—	QO260EPD

QO-K Key operated QO circuit breakers are available in single pole construction and can be mounted in any single pole space which will accept a standard QO. These circuit breakers can be turned ON or OFF or to RESET with a special key (Catalogue Number **QOK10**) included with the circuit breaker.

Ampere Rating	One Pole 120Vac
	10,000 AIR
10	QO110K
15	QO115K
20	QO120K
30	QO130K

QO-HM QO circuit breaker with high magnetics to withstand higher inrush currents than standard QO breaker.

Ampere Rating	One Pole 120Vac
	10,000 AIR
15	QO115HM
20	QO120HM

Note:
QO GFI, EPD, AFI, CAFI, and DF cannot be backfed.

QO Combination Arc-Fault Interrupter (CAFI)

QO Combination Arc-Fault Interrupter (CAFI) provides overload and short circuit protection, plus both series and parallel type arc protection as required in 2015 CEC. Integrated with Time Saver diagnostics, QO CAFI breaker improves circuit troubleshooting at the touch of a button..

Circuit Breaker Type	Ampere Rating	1P 120 Vac 10K AIR 1 Space Required	1P 120 Vac 22K AIR 1 Space Required	2P 120/240 Vac 10K AIR 2 Space Required	2P 120/240 Vac 22K AIR 2 Space Required
		QO Pigtail Neutral CAFI	15	QO115CAFI	QO115VHCAFI
	20	QO120CAFI	QO120VHCAFI	QO220CAFI*	QO220VHCAFI*
QO Plug-on Neutral CAFI	15	QO115PCAFI	QO115VHPCAFI		
	20	QO120PCAFI	QO120VHPCAFI		

* Rated for 120/240 ~60Hz, not for 208Y/120V

QO Dual Function Circuit Breaker

QO Dual Function (DF) breaker provides both combination arc-fault and ground-fault (5mA classA) protection in a single compact device. Integrated with Plug-on Neutral and Time Saver Diagnostics features, QO DF breaker offers maximum circuit protection and installation flexibility.

Circuit Breaker Type	Ampere Rating	1P 120 Vac 10k AIR 1 Space Required	1P 120 Vac 22k AIR 1 Space Required
QO Dual Function Circuit Breaker with Pigtail Neutral	15	QO115DF	QO115VHDF
	20	QO120DF	QO120VHDF
QO Plug-on Neutral Dual Function Circuit Breaker	15	QO115PDF	QO115VHPDF
	20	QO120PDF	QO120VHPDF

QO-HID Circuit Breakers -

QO-HID For Use on High Intensity Discharge Lighting Systems

HID circuit breakers are for use on circuits feeding fluorescent and High Intensity Discharge (HID) lighting systems such as mercury vapour, metal halide, or high pressure sodium. These circuit breakers are physically interchangeable with QO circuit breakers.

Ampere Rating	One Pole 120/240Vac	Two Pole-Common Trip 120/240Vac	Three Pole-Common Trip 240Vac
	10,000 AIR	10,000 AIR	10,000 AIR
15	QO115HID▲	QO215HID	QO315HID
20	QO120HID▲	QO220HID	QO320HID
25	QO125HID	QO225HID	QO325HID
30	QO130HID	QO230HID	QO330HID
40	QO140HID	QO240HID	—
50	QO150HID	QO250HID	—

Application Information

- VISI-TRIP indication on all QO breakers.
- QO, VISI-TRIP and QWIK-GARD are registered trademarks of Square D.
- For more information consult Exmas International Solutions Electric.

Circuit Breaker Wire Sizes

Breaker Type	Ampere Rating	Wire Size (AWG)	
		Aluminum	Copper
QO 1 Pole	10-30	#14-8	#14-8
	10-30	—	(2) #14-10
	35-70	#8-2	#8-2
QO 2 & 3 Pole	10-30	#14-8	#14-8
	35-70	#8-2	#8-2
	80-125	#12-2/0	#12-2/0
QOT	15-20	#12-8	#14-8
QO-GFI & QO-EPD	15-30	#12-8	#14-8
	40-60	#12-4	#14-6

Main Breakers

Main Breaker Frame Size	Amperage +	kAIC	Catalogue Number	Lug Wire Size AWG/KCMIL Al or Cu
QOM1	30	10	QOM30L	#12-2/0
	40		QOM40L	
	50		QOM50L	
	60		QOM60L	
	50	22	QOM50VHL	
	60		QOM60VHL	
	70		QOM70VHL	
	80		QOM80VHL	
100	QOM100VHL			
125	QOM125VHL			
QOM2 ▲	100	22	QOM2100VHL	#4-250
	125		QOM2125VHL	
	150		QOM2150VHL	
	175		QOM2175VHL	
	200		QOM2200VHL	
	225		QOM2225VHL	

- ▲ Add suffix - 1021 for 240Vac shunt trip. Factory Installed Accessory
 - + Do not exceed the load centre mains rating.
- Main Breakers include factory installed handle padlock attachment (padlock QOM main circuit breaker in the 'off' position).

Circuit Breaker Factory Installed Accessories

Requires Additional Pole Space. Only one accessory per breaker. QO accessory terminals for (2) #14-12 Cu. Accessories are not available for Q2, QOM1, or QOB-VH (110-150 A) circuit breakers or QO molded case switches.

Factory Installed Accessories	Available On Breaker	Description	Add Suffix To Breaker Catalogue No.
Shunt Trip	QO	120Vac 208Vac 240Vac	1021
		12Vac 24Vdc 12Vdc 24Vdc	1042
Auxiliary Switch	QO,-GFI,-EPD,	"A" Contact	1200
		"B" Contact	1201
Alarm Switch	QO,-GFI,-EPD,	120Vac	2100

10-30 ampere breakers are suitable for use with 60°C or 75°C conductors, 35-60 ampere breakers are suitable for use with 75°C conductors.

▲ SWD (switching duty) rated. Suitable for switching 120Vac fluorescent lighting loads.

* Combination AFI devices provide protection against both high-energy parallel arcing (same as existing branch/feeder AFCI's) and low energy (5A) series arcing.



QO One Pole with Shunt Trip



QOK Key Operated

QO[®] Loadcentres and Circuit Breakers

QO[®] Main Lugs Loadcentres - Type 1 Indoor

QO[®] Main Lugs Loadcentres (1Ø - 3W)

Mains Ampere Rating	Number of Circuits		Loadcentre Catalogue Number	Trim Catalogue Number	Main Wire Size Al or Cu (AWG/MCM)	Box Size (see page 16)
	Standard QO	Tandem QO				
30	1	2	QO1L30S●	Included	12-10 Al or 14-10 Cu	1
	2	4	QO2L30SC●	Included	12-10 Al or 14-10 Cu	2
70	2	4	QO2L70S+	Included	12-3 Al or 14-4 Cu	3
100	4	8	QO4L100S▲	Included	8-1	4
	6	12	QO6L100S/F▲	Included	8-1	4
	8	15	QO8L100S/F▲	Included	8-1	4
	12	24	CQO112L100PGCd	Included	4-1	7
	16	30	CQO116L100PGCd	Included	4-1	7
125	24	44	CQO124L125PGCd	Included	4-2/0	8
	32	53	CQO132L125PGCd	Included	4-2/0	9
	40	53	CQO140L125PGCd	Included	4-250	11
200	32	64	CQO132L200PGCd	Included	4-250	11
	40	80	CQO140L200PGCd	Included	4-250	11
225	42	80	CQO142L225PGCd	Included	4-300	12
	60	80	CQO160L225PGCd	Included◆	4-300	14

QO[®] Main Lugs Loadcentres (3Ø - 4W)

Mains Ampere Rating	Number of Circuits		Loadcentre Catalogue Number	Trim Catalogue Number	Main Wire Size Al or Cu (AWG/MCM)	Box Size (see page 16)
	Standard QO	Tandem QO				
100	3▼		QO403L100S	Included	12-1 Al or 14-1 Cu	5
125	12▼	24	QO312ML1	QOC16UC	4-2/0	7
	20▼	40	QO320ML1	QOC24UC	4-2/0	8
200	24▼	48	QO324ML2	QOC30UC	4-250	10
	30▼	60	QO330ML2	QOC30UC	4-250	10
225	42▼	60	QO342ML2	QOC42UC	4-300	12

QO[®] Generator Panel (1Ø - 3W)

Mains Ampere Rating	Total Number of Circuits		Number of circuits available for (generator) critical loads		Loadcentre Catalogue Number	Main Wire Size Al or Cu (AWG/MCM)	Box Size (see page 16)
	Standard QO	Tandem QO	Standard QO	Tandem QO			
30			4	8	CQO48M30DSGP	#14-8	4
60			4	8	CQO48M60DSGP	#8-2	4
30			18	36	QOGP3P3036Pd	#14-8	7
60			18	36	QOGP3P6036Pd	#8-2	7

QO[®] 'all-in-one' SE Generator Panels

200	40	80	18	36	QOGP3P604436200Pd	#4-250	13
150	40	80	18	36	QOGP3P604436150Pd	#4-250	13
125	40	80	18	36	QOGP3P604436125Pd	#4-250	13
100	40	80	18	36	QOGP3P604436100Pd	#4-250	13

Service entrance approved.

- Will not accept QO-GFI or QO-EPD breakers.
 - + Maximum 20A QO-GFI breaker or AFI breaker.
 - ▲ Maximum 70A branch breaker.
 - ◆ Does not include a door. Order kit # QODK60-2.
 - ▼ Shunt trip feature not available on any 3Ø loadcentres.
- Feed-thru lugs cannot be added in field-use QO3125SL.

d Plug-on neutral loadcentre

- Bus on 2-8 cct loadcentres is one piece, solid aluminum.
- Bus on 12-60 cct loadcentres is one piece, tin plated copper
- Neutral terminals, main and ground lugs on all devices are Aluminum.

Application Information

- All loadcentres are suitable for both flush or surface mounting, unless suffixed:
 - F - flush mounting only.
 - S - surface mounting only.
- All Type 1 loadcentres are approved for vertical, horizontal, or inverted mounting.
- All 100A loadcentres are approved for 100A max. QO branch circuit breakers.
- All 125A loadcentres are approved for 125A max. QO branch circuit breakers.
- The maximum QO branch circuit breaker is 70 ampere (single pole), 200 ampere (two pole) and 100 ampere (three pole). Two pole QO breakers rated 150 - 200 ampere are restricted to Square D QO Single Phase load center, Series G1.
- Main lugs loadcentres cannot be field converted to service entrance approved, main breaker loadcentres.
- QO is a registered trademark of Square D.
- For more information, consult Exmas International Solutions Electric.
- GC includes ground bar combination surface/flush cover.

QO[®] Loadcentres and Circuit Breakers

QO[®] Main Breaker Loadcentres - Type 1 Indoor

DE1 LOADCENTRES

Main Breaker Loadcentres (1PH - 3W)

Bus Ampere Rating	Main Breaker Amps	Number of Circuits		Loadcentre Catalogue Number	Trim Catalogue Number	Main Wire Size Al/Cu (AWG/MCM)	Box Size (see page 16)
		Standard QO	Tandem QO				
Main Breaker Factory Installed							
100	60	12	24	CQO112M60PCd	Included	4 - 1	6
	100	12	24	CQO112M100PCd	Included	4 - 1	6
	60	16	30	CQO116M60PCd	Included	4 - 1	7
	100	16	32	CQO116M100PCd	Included	4 - 1	7
125	60	24	44	CQO124M60PCd	Included	4-2/0	8
	100	24	44	CQO124M100PCd	Included	4-2/0	8
	100	32	53	CQO132M100PCd	Included	4-2/0	9
	125	32	53	CQO132M125PCd	Included	4-2/0	9
	100	40	53	CQO140M100PCd	Included	4-2/0	11
	125	40	53	CQO140M125PCd	Included	4-2/0	11

Main Breaker Factory Installed

200	200	32	64	CQO132M200PCd	Included	4-250	11
		40	80	CQO140M200PCd	Included	4-250	11
225	200	60	80	CQO160M200PC ^d	Included ^d	4-250	14

Main Breaker Loadcentres (3Ø - 4W)

Bus Ampere Rating	Main Breaker Amps	Number of Circuits		Loadcentre Catalogue Number	Trim Catalogue Number	Main Wire Size Al or Cu (AWG/MCM)	Box Size (see page 16)
		Standard QO	Tandem QO				
Main Breaker Factory Installed (QO3100VH & QDL32200)							
100	100	24	30	QO324MB100	QOC30UC	4-250	10
200	200	42	60	QO342MQB200	QOC342UQC	4-250	13

◆ Does not include a door. Order kit # QODK60-2.

● Rated 200A maximum with Aluminum conductors and 225A maximum with Copper conductors.

• Bus on all devices is one-piece, solid copper, standard.
• Neutral terminals, main and ground lugs on all devices are Aluminum, standard.

d Plug-on neutral loadcentre

NQ Service Entrance Main Breaker Loadcentres

Main Rating	Catalogue Number	1 or 3 Phase	Space		Main Breaker	Enclosure Width	Trim Type
			Standard QO	Tandem QO			
300A	NQSE142300F	1 phase	42	84	Factory Installed	20"	Flush
	NQSE184300F	1 phase	84	120		20"	Flush
	NQSE142300S	1 phase	42	84		20"	Surface
	NQSE184300S	1 phase	84	120		20"	Surface
400A	NQSE142400F	1 phase	42	84		20"	Flush
	NQSE184400F	1 phase	84	120		20"	Flush
	NQSE142400S	1 phase	42	84		20"	Surface
	NQSE184400S	1phase	84	120		20"	Surface

Application Information

• All loadcentres are suitable for both flush or surface mounting.
• All Type 1 loadcentres are approved for vertical, horizontal, or inverted mounting.
• All 100A loadcentres are approved for 100A max. QO branch circuit breakers.

• All 125A loadcentres are approved for 125A max. QO branch circuit breakers.
• The maximum QO branch circuit breaker is 70 ampere (single pole), 200 ampere (two pole) and 100 ampere (three pole). Two pole QO breakers rated 150 - 200 ampere are restricted to Square D QO Single Phase load center, Series G1.

• Main Breaker loadcentres are approved for service entrance use. The main breaker compartment can be sealed and the main breaker can be locked.
• QO-L main breakers are 10 kAIC rated, QO-VHL main breakers are 22 kAIC rated.
• QO is a registered trademark of Square D.
• For more information, consult Exmas International Solutions Electric.

QO[®] Loadcentres and Circuit Breakers

QO[®] Main Lugs/Main Breaker Loadcentres - Type 3R Weatherproof

Main Lugs Loadcentres (1Ø - 3W)

Bus Ampere Rating	Number of Circuits		Loadcentre Catalogue Number	Trim Catalogue Number	Main Wire Size Al or Cu (AWG/MCM)	Box Size (see page 16)
	Standard QO	Tandem QO				
70	2	4	QO2L70RB + X	Included	12-3 Al or 14-4Cu	1RB
	6	12	QO6L100RB	Included	8-1	2RB
100	8	15	QO8L100RB	Included	8-1	2RB
	16	30	CQO116L100PGRBd	Included	4-1	6RB
125	24	44	CQO124L125PGRBd	Included	4-2/0	6RB
200	40	80	CQO140L200PGRBd	Included	4-250	8RB

Main Lugs Loadcentres (3Ø - 4W)

Bus Ampere Rating	Number of Circuits		Loadcentre Catalogue Number	Trim Catalogue Number	Main Wire Size Al or Cu (AWG/MCM)	Box Size (see page 16)
	Standard QO	Tandem QO				
100	3		QO403L100RB	Included	12-1 Al or 14-1 Cu	3RB
125	12	24	QO312ML1RB	Included	4-2/0	4RB
125	20	40	QO320ML1RB	Included	4-2/0	5RB
200	30	60	QO330ML2RB	Included	4-250	7RB
225	42	60	QO342ML2RB	Included	4-300	9RB

Main Breaker Loadcentres (1Ø - 3W)

Bus Ampere Rating	Main Breaker Amps	Number of Circuits		Loadcentre Catalogue Number	Trim Catalogue Number	Main Wire Size Al/Cu (AWG/MCM)	Box Size (see page 16)
		Standard QO	Tandem QO				

Main Breaker Factory Installed

100	60	8	16	CQO018M100RB60	Included	4 - 1	4RB
100	100	16	30	CQO116M100PRBd	Included	4 - 1	6RB
125	100	24	44	CQO124M100PRBd	Included	4-2/0	6RB

Main Breaker Factory Installed

200	200	40	80	CQO140M200PRBd	Included	4-250	8RB
-----	-----	----	----	----------------	----------	-------	-----

Non-Metallic Enclosure (1Ø - 3W) Type 3R

Bus Ampere Rating	Number of Circuits		Loadcentre Catalogue Number	Trim Catalogue Number	Main Wire Size Al/Cu (AWG/MCM)	Box Size (see page 15)
	Standard QO	Tandem QO				
60	2	4	CQO24L60NRNM	Included	#14-4 / #14-4	1NM

QO Hot Tub / Pool / Spa Pack

20 to 60 amp non-metallic	2 pole QOGFCI factory installed into a type 3R enclosure	CQOE220GFINM
		CQOE230GFINM
		CQOE240GFINM
		CQOE250GFINM
		CQOE260GFINM▼

+ Maximum 20 A QO-GFI breaker.

▼ 60 amp, 2 wire 240V only. **Not for hot tubs with neutral connection.**

Service Entrance approved.

X Not rated for 22k AIC.

d Plug-on neutral loadcentre

- Bus on 2-8 cct loadcentres is one-piece, solid aluminum. (Excluding CQO18M100RB.)
- Bus on 8-42 cct, S-Series loadcentres is one-piece, solid copper.
- Neutral terminals, main and ground lugs on all devices are Aluminum.



Application Information

- All 100A loadcentres are approved for 100A max. QO branch circuit breakers.
- All 125A loadcentres are approved for 125A max. QO branch circuit breakers.
- The maximum QO branch circuit breaker is 70 ampere (single pole), 200 ampere (two pole) and 100 ampere

(three pole). Two pole QO breakers rated 150 - 200 ampere are restricted to Square D QO Single Phase load center, Series G1..

- Main Breaker loadcentres are approved for service entrance use. The main breaker compartment can be sealed and the main breaker can be locked.

- Main lugs loadcentres cannot be field converted to service entrance approved, mainbreaker loadcentres.
- Weatherproof Loadcentres are supplied with main entry hole cut in top endwall and closing cap (BCAP) installed. Hole accepts 3/4 in. to 2 in. hubs. Gasket not required.
- QO is a registered trademark of Square D.

QO® Loadcentres and Circuit Breakers

QO® Recreational Vehicle Park Loadcentres (ServicePak®) QO® Mobile Home and Trailer Loadcentres

DE1 LOAD CENTRES

Recreational Vehicle Park Loadcentres (ServicePak® Panels)

Ampere Rating		Spaces	Power Outlet Config.	Service	Canada Catalogue No.	Series	Main Wire Size (AWG/MCM)		Box Size (see page 16)
Mains	Sub-feed						Al	Cu	
Underground or Overhead Loop-Feed Terminals - Non-Pedestal Mounted ◆									
40	40	2	A	1Ø2W	QO2RV40A QO2RV40AG	E01	14-6	12-6	RVP1
50	50	2	B	1Ø2W	QO2RV50B QO2RV50BG QO2RV50BGFI	E01	14-6	12-6	RVP1
75	75	3	C	1Ø2W	QO3RV75C QO3RV75CG QO3RV75CGFI	E01	14-1	12-1	RVP2
Underground Loop-Feed Terminals - Pedestal Mounted ●									
50	200	2	B	1Ø2W	QO2RVP50B QO2RVP50BG QO2RVP50BGFI	E01	6-250		RVP1+Pedestal
75	200	3	C	1Ø2W	QO3RVP75C QO3RVP75CG QO3RVP75CGFI	E01	6-250		RVP2+Pedestal
100	200	4	D	1Ø3W	QO4RVP100D QO4RVP100DG QO4RVP100DGFI	E02	6-250		RVP2+Pedestal

- Provide electrical power to individual recreational vehicle park sites.
- Each receptacle protected by appropriate GFI or Standard QO® circuit breaker.
- All receptacles and circuit breakers included.
- 10,000 RMS Symmetrical Ampere short circuit current rating.
- All enclosures are rainproof.
- No neutral bonding provisions.
- Loop-Feed provisions.
- Type 3R weatherproof.
- Optional configurations not available.
- Pedestal is factory installed only.

Power Outlet Configurations - Description

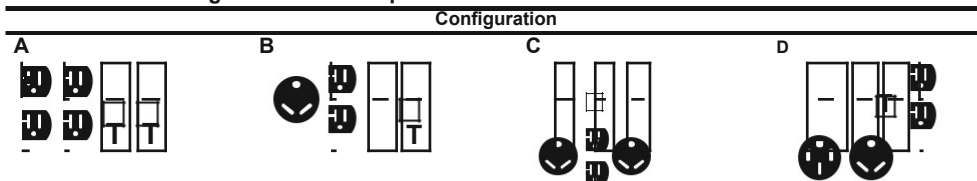

Receptacles	Catalogue Number Suffix	Canada Catalogue No.
configuration A non-pedestal	STANDARD DEVICE - 2xQO115 + 2x 15A 120v recept G = 2xQO115GFI factory installed	QO2RV40A QO2RV40AG
configuration B non-pedestal	STANDARD DEVICE - 1xQO115+ 1xQO130 + 1x15A, 1x30A 120v recept G = 1xQO115GFI & 1xQO130 factory installed GFI = 1xQO115GFI & 1xQO130GFI factory installed	QO2RV50B QO2RV50BG QO2RV50BGFI
configuration C non-pedestal	STANDARD DEVICE - 1xQO115+ 2xQO130 + 1x15A, 2x30A 120v recept G = 1xQO115GFI & 2xQO130 factory installed	QO3RV75C QO3RV75CG
configuration B pedestal	STANDARD DEVICE - 1xQO115+ 1xQO130 + 1x15A, 1x30A 120v recept G = 1xQO115GFI & 1xQO130 factory installed GFI = 1xQO115GFI & 1xQO130GFI factory installed	QO2RVP50B QO2RVP50BG QO2RVP50BGFI
configuration C pedestal	STANDARD DEVICE - 1xQO115+ 2xQO130 + 1x15A, 2x30A 120v recept GFI = 1xQO115GFI & 2xQO130GFI factory installed	QO3RVP75C QO3RVP75CGFI
configuration D pedestal	STANDARD DEVICE - 1xQO115+ 1xQO130 + 1xQO250 + 1x15A, 1x30A 120v recept & 1x50A 120/240v recept G = 1xQO115GFI & 1xQO130 & 1xQO250 factory installed GFI = 1xQO115GFI & 1x10130GFI & 1xQO250 factory installed	QO4RVP100D QO4RVP100DG QO4RVP100DGFI



Mobile Home and Trailer Loadcentres

Mains Ampere Rating	Spaces	Service	Catalogue Number	Series	Main Wire Size (AWG/MCM)		Box Size (see page 16)
					Al	Cu	
Main Lugs Loadcentres							
30	2	1Ø2W	QO2L30TTS ‡	G01	12-10	14-10	MH1
50	2	1Ø2W	QO2L50TTS ‡	G01	—	14-6	MH2
70	2	1Ø3W	QO2L70TS	G01	12-3	14-4	MH2
100	6	1Ø3W	QO612L100TF/S †	G01		4 - 1	MH3
100	6	1Ø3W	QO612L100DTF/S †	G01		4 - 1	MH3

- ◆ Non-pedestal devices are supplied with main entry hole cut in top endwall and have closing cap (BCAP) installed. Hole accepts 3/4 in. to 2 1/2 in. hubs. Gasket not required.
- ◆ Non-pedestal devices have provisions to field install a Type "B" bolt on hub on the bottom endwall. For bottom feed from a conduit riser, order Type "B" hub and two mounting screws P/N: **8002505501**; and two hex nuts, P/N: **2340102000**.
- For pedestal devices, a stabilizer foot is available for use in unstable ground, P/N: **HNPSF**.
- ‡ Will not accept QO-GFI circuit breakers.
- † Use #10 maximum size wire for QO-GFI circuit breakers.
- † 70A Max. branch circuit breaker and 70A Max. back fed main circuit breaker.

Application Information

- All Servicepak® Panels have their breakers and receptacles factory installed and prewired.
- Mobile Home and Trailer Loadcentres do not come with factory installed breakers. Order separately.
- Servicepak® Panels and Mobile Home and Trailer Loadcentres are not suitable for use as service equipment.
- All Servicepak® devices are set up for Loop-fed, therefore, there are 2 wires per phase, neutral and equipment ground.
- Servicepak® devices are suitable for surface mounting only.
- Power Outlet Configurations, other than those shown above, are not available.
- Servicepak® is a Registered Trademark of Square D.
- For more information, consult Exmas International Solutions Electric.

QO[®] Loadcentres and Circuit Breakers

DE1 LOAD CENTRES

Accessories

	Description	Catalogue Number
Handle Attachments		
Handle Tie:	Converts any two adjacent 120/240Vac single pole QO breakers to independent trip two pole.....	QO1HT
	Converts any two adjacent 120/240Vac single pole side-by-side Tandem breakers to independent trip two pole QOTHT	
Handle Lock-Off:	Clamp for holding QO single pole handle in "ON" or "OFF" position	QO1LO
	Clamp for holding QO, either 1, 2 or 3-pole breaker handles in "ON" or "OFF" position.....	HLO1
Handle Padlock Attachment:	For padlocking single pole QO breaker in "ON" or "OFF" position	
	Loose Attachment	QOHPL
	Fixed Attachment	QO1PA
	For padlocking single pole side-by-side QO Tandem breaker in "ON" or "OFF" position....	QOTHPA
	For 2 and 3-pole QO breakers which require padlocking in either "ON" or "OFF" position	
	Loose Attachment.....	QO1HPL
	Fixed Attachment.....	QO1PL
	For padlocking QOM main circuit breakers in "OFF"..... 50-125A.....	QOM1PA
	150-225A.....	QOM2PA
	For padlocking 2-Pole QO-GFI in either "ON" or "OFF" position.....	GFI2PA
Mechanical Interlock Attachment:	For interlocking the handles of two 2-pole or one 2-pole and one 1-pole QO breakers mounted side-by-side so that only one breaker can be "ON" at a time.....	QO2DTI
Sub-feed lugs		
	125 ampere two pole plug-on – 2 spaces required (#12-2/0 Al/Cu)	QO2125SL
	125 ampere three pole plug-on – 3 spaces required (#12-2/0 Al/Cu).....	QO3125SL
Filler Plates		
	Fills branch breaker openings in cover	QOFF
	Fills QOM1 main breaker opening in cover..... 100-125A.....	QOM1FP
	Fills QOM2 main breaker opening in cover..... 150-225A.....	QOM2FP
	Fills main breaker opening in 3Ø covers (S-Series)	KFP
Lock Kits		
	Converts door latch from spring catch to lock type.....	PK6FL
Neutral / Ground Lugs		
	Field installed for #12 to 2 Al or #14 to 4 Cu wire	LK70AN
	Field installed for #6 to 2/0 Al/Cu wire	LK100AN
	Field installed for #14 to 2/0 Al/Cu wire	LK125AN
	Field installed for #2 to 3/0 Al/Cu wire	LK150AN
	Field installed for #4 to 300 MCM Al/Cu	LK225AN
Neutral Extension kits		
	Field installed on 1ph QO loadcentres	See page DE1-12
Ground Bar Kits		
	Standard PK15GTA with a #1 to 4/0 Cu/Al Lug.....	PK15GTAL
	Standard PK18GTA with a #1 to 4/0 Cu/Al Lug.....	PK18GTAL
	Standard PK23GTA with a #1 to 4/0 Cu/Al Lug.....	PK23GTAL
	Insulator Kit for PK9GTA thru PK27GTA.....	PKGTAB
Miscellaneous		
	QO main breaker barrier.....	4055952201
Retaining Kit:	Secures circuit breaker to interior when used as a back-fed main.	
	For use on QO6L100S/F, RB and QO8L100S/F, RB Loadcentres.....	PK2MB
	Secures circuit breaker to interior when used as a back-fed main. For 3Ø Loadcentres (S-Series).....	PK3MB
Cover Sealing Strap:	Provides means of sealing trim mounting screws on QO load centre covers..	QO1SE
Joint Compound	For use on plug-on connectors only. Recommended for use whenever QO plug-on breakers are removed and reinstalled for any reason. 57g container.....	PJC7201
Touch-up Paint	Aerosol spray paint can – ASA 49	PK49SP

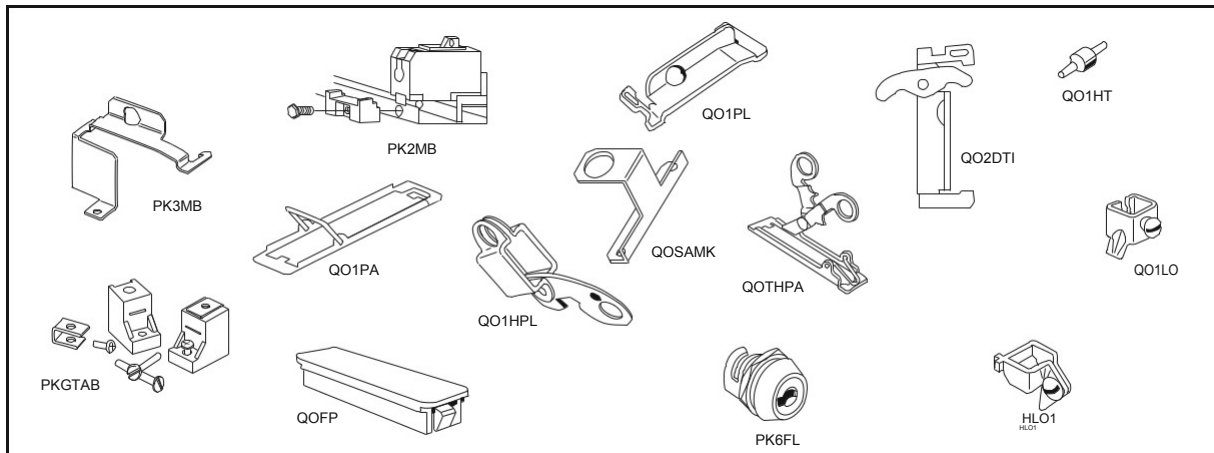

Loadcentre catalogue number	Reference neutral kit(s)*	Loadcentre catalogue number	Reference neutral kit(s)*
CQO124L125PGC	1	CQO140L200PGRB	1 or 2
CQO124L125PGRB	1	CQO140M100PC	1 or 2
CQO124M60PC	1	CQO140M125PC	1 or 2
CQO124M100PC	1	CQO140M150PC	1 or 2
CQO124M100PRB	1	CQO140M200PC	1 or 2
CQO132L125PGC	1	CQO140M200PRB	1 or 2
CQO132L200PGC	1	CQO142L225PGC	1 or 2
CQO132M100PC	1	CQO160L225PG	1
CQO132M125PC	1	CQO160M200PC	1
CQO132M60PC	1	CQO124M60PCD	1
CQO132M70PC	1	CQO124M100PCD	1
CQO132M200PC	1	CQO132M100PCD	1
CQO140L125PGC	1 or 2	CQO132M125PCD	1
CQO140L200PGC	1 or 2	CQO140M200PCD	1 or 2

* Neutral kit reference number description

Reference neutral kit(s)	Neutral kit catalogue number	Neutral kit description
1	QONK1	14 neutral ports x 2
2	QONK2	22 neutral ports x 2

*Installing the Neutral Bar Extensions

When installing the QO neutral bar extension kits, circuit breaker mounting spaces need to be left open below the neutral extension kits for ground fault interrupters, arc fault interrupters and the larger amperage branch circuit breakers rated 150–200 A that would extend beyond the neutral bars. These circuit breaker types will not fit over the QO neutral extension kit bars.

QO neutral kit - customer opportunities

- Increased installation flexibility
- Enhanced retro-fit opportunities

QO neutral kit - advantages

- Multiple length kits available
- Kit includes a left and right side neutral bar
- Left side or right side installation option

Application Information

- For more information, contact our Customer Information Centre @ 1-800-565-6699.
- QO is a registered trademarks of Square D.
- For more information consult Exmas International Solutions Electric.

SURGEBREAKER PLUS[®]

- Suitable for use in service entrance locations.
- Meets requirements of CSA C22.2 No. 8, UL 1449, 3rd Edition, ANSI/IEEE C62.41 and cULus Listed.
- AC line protection.
- Four line telephone protection.
- Two line coaxial protection.
- Suitable for indoor applications only.
- Flush or surface mounting.
- LED status indicator.
- Modular design with optional accessories.

Single Phase Three Wire – 120/240 Vac

Description	Catalogue Number
Surgebreaker Plus	SDSB80111C



SDSB80111C

Plug-on Neutral QO[™] Surge Protective Device

- Suitable for use in service entrance locations
- Meets CSA C22.2 No. 269.1, C233.1
- LED indicates operational status.
- Type 1 Surge Protective Device

Description	Catalogue Number
Plug-on Neutral QO [™] Surgebreaker cULus Listed 150Vac line-to-ground maximum	CQO250PSPD



CQO250PSPD

QO[™] Surge Protective Device

- Suitable for use in service entrance locations
- Meets CSA C22.2 No. 8-M1986, C233.1-87
- LED indicates operational status.
- Type 2 Surge Protective Device

Description	Catalogue Number
QO [™] Surgebreaker cULus Listed 150Vac line-to-ground maximum	QO2175SB



QO2175SB

Hard-Wired Secondary Surge Arresters

- Suitable for use in service entrance locations.
- cULus Listed Secondary Surge Arresters.
- Meets CSA C233.1, ANSI/IEEE C62.11.
- Suitable for indoor and outdoor applications.
- LED indicates operational status.

Description	Catalogue Number
SECONDARY SURGE ARRESTER For 1Ø systems. 150Vac phase-to-ground maximum.	SDSA1175 ■
SECONDARY SURGE ARRESTER for 1Ø systems. 150Vac phase-to-ground maximum. ●	SDSA3650

- Catalogue Number QOSAMK required for installation in QO loadcentres (see page DE1-11 for diagram).
- Do not use on ungrounded systems. Systems must be solidly grounded.



SDSA1175



SDSA3650

Application Information

- For more information, please refer to catalogue No. 6671CT9701 or DE-7.

Enclosure Dimensions

Type 1 QO Loadcentre Enclosures

Type 1 Box Size	Height (in./mm)	Width (in./mm)	Depth (in./mm)
1	5.50/140	3.00/76	3.50/89
2	6.75/171	3.75/95	3.00/76
3	9.25/235	4.75/121	3.25/83
4	12.75/324	9.00/229	3.75/95
5	13.25/337	6.00/152	3.50/89
6	14.80/376	14.25/362	3.75/95
7	17.80/452	14.25/362	3.75/95
8	20.80/528	14.25/362	3.75/95
9	25.90/658	14.25/362	3.75/95
10	30.00/762	14.25/362	3.75/95
11	33.66/855	14.25/362	3.75/95
12	38.00/965	14.25/362	3.75/95
13	39.25/997	14.25/362	3.75/95
14	41.00/1048	14.25/362	3.75/95

Type 3R QO Loadcentre Enclosures

Type 3R Box Size	Height (in./mm)	Width (in./mm)	Depth (in./mm)
1NM	9.80/245	6.5/162.5	3.9/97.5
1RB	9.50/241	5.00/127	4.00/102
2RB	12.75/324	9.00/229	4.25/108
3RB	13.00/330	6.75/171	4.00/102
4RB	19.00/483	14.25/362	4.50/114
5RB	22.00/559	14.25/362	4.50/114
6RB	22.25/565	14.25/362	4.50/114
7RB	30.00/762	14.25/362	4.50/114
8RB	34.00/864	14.25/362	4.50/114
9RB	38.00/965	14.25/362	4.50/114

Recreational Vehicle Park Loadcentres

Box Size	Height (in./mm)	Width (in./mm)	Depth (in./mm)
RVP1	8.50/216	7.75/197	5.80/147
RVP2	16.40/417	7.75/197	5.80/147
Pedestal	50.90/129	7.60/193	3.50/89

Mobile Home and Trailer Loadcentres

Box Size	Height (in./mm)	Width (in./mm)	Depth (in./mm)
MH1	6.72/171	3.81/97	3.00/76
MH2	9.30/236	4.80/122	3.19/81
MH3	12.57/319	8.88/226	3.80/97

Application Information

- Dimensions for approximate only. Do not use for construction.

Canadian HomeLine[®] Circuit Breakers and Loadcentres General Information

Canadian HomeLine[™] Single Phase Loadcentres

DE1 LOAD CENTRES

- Pages:**
- DE1-17 to DE1-34
- Application:**
- Residential, Light Commercial
 - 30 through 225 Amperes
- Standards:**
- CSA Certified under File #LL-89066
- Enclosures:**
- Type 1 and 3R
- Features:**
- One piece, plated, shielded aluminum bus
 - Split branch neutral with 3-1/0 "built in" branch neutral lugs
 - Combination Slot/Robertson neutral, ground and trim screws
 - Additional ground bar provisions
 - Trims have automatic flush adjustment
 - Fusible loadcentre inserts (HFLCI)
- Accessories:**
- Secondary Surge Arresters
 - Sub-Feed Lugs
 - Filler Plates (for branch and main breakers)
 - Door Lock Kits
 - Neutral Lugs
 - Neutral extension kits



Canadian HomeLine™ Circuit Breakers and Loadcentres Product Description



HomeLine™ Main Breaker Loadcentre

The Residential Solution for Canadian Electrical Contractors

HomeLine™ circuit breaker loadcentres from Exmas International Solutions Electric are CSA certified panelboards. They are designed to meet residential requirements to protect electrical systems, equipment, and people.

Features

Indoor (NEMA Type 1), Main Breaker, 12 to 60 spaces

- Single phase, 120/240V
- 200A maximum tin plated aluminum bus
- 60 spaces, 120 circuits max
- Short circuit rating
 - κ standard 22kAIC – main breaker (50A thru 200A) κ
 - series ratings up to 100kAIC
- Distributed neutral bar design
- Robertson/Slot neutral, ground and trim screws
- Shielded bus bar
- Appliance white combination flush/surface mount trim
- Automatic flush trim adjustment with shutter type twistouts
- Top or bottom feed
- Multiple horizontal and vertical ground bar mounting positions
- Straight in wiring for main and branch wiring
- Removable interiors
- Tangential main knockouts
- Provision for optional door lock
- Welded box construction

Indoor (NEMA Type 1), Main Lug, 2 to 42 spaces

- Single phase, 120/240V
- 225A maximum tin plated aluminum bus
- 42 spaces, 84 circuits max
- Short circuit rating
 - κ standard 10kAIC – main lug κ
 - series ratings up to 100kAIC
- Robertson/Slot neutral, ground and trim screws
- 2 to 6 space single row loadcentres, ASA49 grey
- Top or bottom feed
- Welded box construction

HomeLine Fusible Loadcentre Inserts (HFLCI)

Indoor (NEMA Type 1), Main Lug, 12 spaces

- Single phase, 120/240V
- 125A maximum tin plated aluminum bus
- 12 spaces, 24 circuits max
- Short circuit rating
 - κstandard 10kAIC
 - κseries ratings up to 100kAIC
- Robertson/Slot neutral, ground and trim screws
- Architectural white surface mount trim with door



Flush Cover

Outdoor (NEMA Type 3R), Main Breaker, 8 to 20 spaces



RB Device

- Single phase, 120/240V
- 200A maximum tin plated aluminum bus
- 20 spaces, 40 circuits max
- Short circuit rating
 - standard 22kAIC – main breaker ◦
 - series ratings up to 100kAIC
- Distributed neutral bar design
- Robertson/Slot neutral, ground and trim screws
- Shielded bus bar
- Side hinged door
- Welded, galvanealed steel, painted ASA49 grey enclosure
- Gasketless rain hubs – 0.75" to 2.5"
- Stainless steel locking hasp

Outdoor (NEMA Type 3R), Main Lug, 2 to 12 spaces



Bolt-On Hubs

- Single phase, 120/240V
- 125A maximum tin plated aluminum bus
- 12 spaces, 24 circuits max
- Short circuit rating
 - standard 10kAIC – main lug ◦
 - series ratings up to 100kAIC
- Robertson/Slot neutral, ground and trim screws
- Welded, galvanealed steel, painted ASA49 grey enclosure
- Gasketless rain hubs – 0.75" to 2.5"
- Stainless steel locking hasp



QOM1
Frame
Size

QOM2

Frame

Size

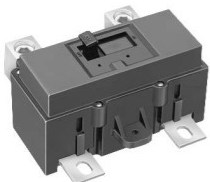
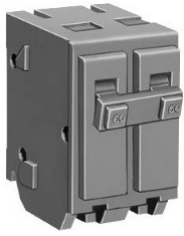

Canadian HomeLine™ Circuit Breakers and Loadcentres Product Description

DE1 LOAD CENTRES

Canadian Catalogue Number logic

HomeLine™ Loadcentres

Number Segment	Character	Description	CHOM	3060	L	200	G	—	C
Load Center Family	CHOM	CSA Listed							
Spaces / Circuits	3060								
Mains Type	M	Main circuit breaker							
	L	Main lugs							
Amps									
Ground Bar	G	Factory included							
Cover	C	Combination flush / surface indoor cover							
	F	Flush							
	RB	Rainproof							
	S	Surface							

HomeLine™ Circuit Breakers

Number Segment	Character	Description	CHOM	1	15	—
Brand	CHOM	Full Size				
	CHOMT	Tandem/Quad				
Number of Poles						
Amps						
Device Name	AFI	Arc fault circuit interruption				
	BB	High amp branch breaker				
	CAFI	Combination arc fault circuit interruption				
	EPD	Equipment protection device, 30mA				
	GFI	Ground fault circuit interruption, 5mA				
	HM	High magnetic trip				
	DF	Dual function				

Notes:

1. CHOM 1pole - 1" wide, 1 space required.
2. CHOM 2pole - 2" wide, 2 spaces required.
3. CHOMT 1pole tandem - 1" wide, 1 space required, represents two 1pole circuit breakers, i.e. CHOMT1515.
4. CHOMT 2pole tandem quad - 2" wide, 2 spaces required, represents two 1pole outer poles and one 2pole inner circuit breaker with common trip, i.e. CHOMT1515220.

Canadian HomeLine[®] Circuit Breakers and Loadcentres Circuit Breakers and Accessories

DE1 LOAD CENTRES

Standard and Main Circuit Breakers

Standard Loadcentre Breakers

Type	Amp Rating	1 Pole Cat. No.	Lug Range	2 Pole Cat. No.	Lug Range	
CHOM ^{1,2&4}	15	CHOM115	#14 - #8	CHOM215	#14 - #8	
	20	CHOM120		CHOM220		
	25	CHOM125		CHOM225		
	30	CHOM130		CHOM230		
	35	—	#8 - #2	CHOM235	#8 - #2	
	40	CHOM140		CHOM240		
	45	—		—		
50	CHOM150	—	CHOM250			
CHOM ⁵ high magnetic	15	CHOM115HM	#14-#8	—		#8 - #2
	20	CHOM120HM		—		
	60	—	—	CHOM260		
	70	—		CHOM270		
	80	—		CHOM280		
CHOM ^{1&3}	90	—	—	CHOM290	#4-2/0	
	100	—		CHOM2100		
	125	—	—	CHOM2125		
	150	—		CHOM2150BB	#4-300mcm	
	175	—		CHOM2175BB		
200	—	CHOM2200BB				

Notes:

1. All CHOM 1 & 2 pole CSA listed as HACR type.
2. CHOM115 & 120 SWD rated.
3. CHOM2P150-2P200 require 4 spaces, use only in single phase loadcentres rated 150A or greater.
4. CHOM 1pole circuit breakers require one space. CHOM 2pole circuit breakers require two spaces.
5. High magnetic trip circuit breakers are recommended for applications where high initial inrush current may occur.

HomeLine Main Circuit Breakers

Type	Amp Rating	2 Pole Cat No.	kAIC	Lug Range
QOM1	30	QOM30L	10	#12-2/0
	40	QOM40L	10	
	50	QOM50VHL	22	
	60	QOM60VHL		
	70	QOM70VHL		
	80	QOM80VHL		
	100	QOM100VHL		
QOM2	125	QOM125VHL	22	#4-300mcm
	100	QOM2100VHL		
	125	QOM2125VHL		
	150	QOM2150VHL		
	175	QOM175VHL		
200	QOM2200VHL			
225	QOM2225VHL			



QOM2

Canadian HomeLine™ Circuit Breakers and Loadcentres Circuit Breakers and Accessories

CHOMT Breakers, Combination Arc Fault Circuit Interrupters, Dual Function Circuit Breakers

DE1 HOMELINE

CHOMT Tandem & Quad Tandem Circuit Breakers

Type	Amp Rating		CHOMT Tandem Cat. No.	Lug Range
CHOMT Tandem 1 & 3	15-15		CHOMT1515	15-30A #14-#8
	15-20		CHOMT1520	
	20-20		CHOMT2020	
	30-15		CHOMT3015	
	30-20		CHOMT3020	
CHOMT Quad Tandem 1, 2 & 4	1P	2P	Quad CHOMT Tandem Cat. No.	15-30A #14-#8 40-50A #6-12 Al #6-14 Cu
	(2)15A	15A	CHOMT1515215	
	(2)15A	20A	CHOMT1515220	
	(2)15A	25A	CHOMT1515225	
	(2)15A	30A	CHOMT1515230	
	(2)15A	40A	CHOMT1515240	
	(2)15A	50A	CHOMT1515250	
	(2)20A	20A	CHOMT2020220	
	(2)20A	25A	CHOMT2020225	
	(2)20A	30A	CHOMT2020230	
	(2)20A	40A	CHOMT2020240	
	(2)20A	50A	CHOMT2020250	

Notes:

1. CSA certified for use as HACR type circuit breakers.
2. Cat# represents two 1P outer poles and one 2P inner circuit breaker with common trip.
3. CHOMT tandems require 1 space.
4. CHOMT quad tandems require 2 spaces.

HomeLine Combination Arc-Fault Interrupter (CAFI)

HomeLine Combination Arc-Fault Interrupter (CAFI) provides overload and short circuit protection, plus both series and parallel type arc protection as required in 2015 CEC. Integrated with Time Saver diagnostics, HomeLine CAFI breaker improves circuit troubleshooting at the touch of a button.

Circuit Breaker Type	Ampere Rating	1P 120 Vac 10K AIR 1 Space Required	2P 120/240 Vac 10K AIR 2 Space Required
HomeLine Pigtail Neutral CAFI	15	CHOM115CAFI	CHOM215CAFI*
	20	CHOM120CAFI	CHOM220CAFI*
HomeLine Plug-on Neutral CAFI	15	CHOM115PCAFI	
	20	CHOM120PCAFI	

* Rated for 120/240V ~ 60 Hz, not for 208Y/120V

HomeLine Dual Function Circuit Breaker

HomeLine Dual Function (DF) breaker provides both combination arc-fault and ground-fault (5mA classA) protection in a single compact device. Integrated with Plug-on Neutral and Time Saver Diagnostics features, HomeLine DF breaker offers maximum circuit protection and installation flexibility.

Circuit Breaker Type	Ampere Rating	1P 120 Vac 10K AIR 1 Space Required
		Catalog Number
HomeLine Dual Function Circuit Breaker with Pigtail Neutral	15	CHOM115DF
	20	CHOM120DF
HomeLine Plug-on Neutral Dual Function Circuit Breaker	15	CHOM115PDF
	20	CHOM120PDF

Canadian HomeLineTM Circuit Breakers and Loadcentres Circuit Breakers and Accessories

DE1 LOAD CENTRES

Ground Fault Circuit Interrupters, Arc Fault Circuit Interrupters

HomeLine GFI with 5 mA Sensitivity (Class A)

Amp Rating	1 Pole Cat. No.	2 Pole Cat. No.
15	CHOM115GFI	CHOM215GFI
20	CHOM120GFI	CHOM220GFI
30		CHOM230GFI
40		CHOM240GFI
50		CHOM250GFI

HomeLine EPD with 30 mA Sensitivity

Type	1 Pole Cat. No.	2 Pole Cat. No.
15	CHOM115EPD	CHOM215EPD
20	CHOM120EPD	CHOM220EPD
30		CHOM230EPD
40		CHOM240EPD
50		CHOM250EPD

Notes:

- GFI breakers maximum 250 feet (one way) feeder length
- Use solid conductor only when #14 wire is used



CHOM115GFI



CHOM230GFI



CHOM115PCAFI



CHOM215CAFI



CHOM115CAFI

Ground Fault Devices (GFI)

Spa Pack

A complete kit consisting of a Type 3R enclosure, factory installed 2P50A GFCI circuit breaker.

Spa Pack

Amp Rating	Poles	Cat. No.
50	2	CHOME250SPA

Canadian HomeLine Breaker Accessories

Description	Cat. No.
Handle attachments	
Handle tie, converts any 2 adjacent 1P HOM circuit breakers to independent trip 2P	HOM1HT
Handle tie, converts any adjacent 1P side by side HOMT CB's to independent 2P	HOMTHT
Handle lock, ON or OFF, nonpadlocking HomeLine 1p 15-50A CB	QO1LO
Handle blocking device, attaches to a HOM 2P CB for holding the handle in the OFF position	HOM2HBD
Handle lock, ON or OFF, padlocking HomeLine 1p 15-50A CB	HOM1PA
2 pole standard HomeLine handle lock ON or OFF, Padlocking	
- Handle padlock attachment, for padlocking 2P 15-70A	HOM2PALA
- Handle padlock attachment, for padlocking 2P 80-125A	HOM2PAHA
- Handle padlock attachment, for padlocking 2P 150-200A	HOM2PAVHA
Handle Padlock Attachment, for padlocking 1P CAFI,DF, GFI, and EPD CHOM breakers in ON or OFF position	HOMELEC1PA
Handle Padlock Attachment, for padlocking 2P CAFI, GFI, and EPDC CHOM breakers in ON or OFF position	HOMELEC2PALA
Handle padlock attachment, for padlocking centre poles of HOM quad breakers in the OFF position	HOMQPA
Handle lock, OFF for QOM1 50-125A Main Circuit Breaker	QOM1PA
Handle lock, OFF for QOM2 100-225A Main Circuit Breaker	QOM2PA
Sub-feed Lugs	
125A 2P plug-on - 2 spaces required	HOML2125
225A 2P plug-on - 4 spaces required	HOML2225

Note: Canadian HomeLine and QO loadcentre accessories may

TM
Canadian HomeLine™ Circuit Breakers and Loadcentres
Type 3R Main Lug and Main Circuit Breaker Loadcentres

Single-Phase, Three-Wire, 120/240 Vac Main Lugs – Indoor

Mains Rating in Amps	Loadcentre Catalogue Number	Maximum Number of Circuits		Loadcentre Cover Catalogue Number	Service Entrance Approved	Maximum Short Circuit Rating	Main Wire Size AWG/kcmil Al/Cu	Enclosure No. (Pages 34-35)	Top or Bottom Mains Position
		Standard 1"	Tandem or Quad						

Factory-Installed Main Lugs

70	CHOM24L70F/S	2	4	Included	N	10,000 A	#12-3 #14-4	2	Top
100	CHOM612L100F/S	6	12	Included	N	10,000 A	#8-1	4	Top
125	CHOM48L125GC	4	8	Included	N	10,000 A	#4-2/0	21	Top

Factory-Installed Main Lugs

125	CHOM816L125GC	8	16	Included	N	10,000 A	#6-2/0	6	Both
	CHOM1224L125GC	12	24	Included	N	10,000 A	#6-2/0	6	Both
	CHOM1632L125GC	16	32	Included	N	10,000 A	#6-2/0	8	Both
	CHOM2448L125GC	24	48	Included	N	10,000 A	#6-2/0	8	Both
	CHOM3060L125GC	30	60	Included	N	10,000 A	#6-2/0	10	Both

Factory-Installed Main Lugs

225	CHOM3060L225GC	30	60	Included	N	10,000 A	#6-250	10	Both
	CHOM4284L225GC	42	84	Included	N	10,000 A	#6-250	12	Both

Single-Phase, Three-Wire, 120/240 Vac Main Circuit Breaker – Indoor

Mains Rating in Amps	Loadcentre Catalogue Number	Maximum Number of Circuits		Loadcentre Cover Catalogue Number	Service Entrance Approved	Maximum Short Circuit Rating	Main Wire Size AWG/kcmil Al/Cu	Enclosure No. (Pages 34-35)	Top or Bottom Mains Position
		Standard 1"	Tandem or Quad						

Factory-Installed Main Circuit Breaker

30	CHOM1224M30GC	12	24	Included	Y	10,000 A	#6-2/0	6	Both
50	CHOM1224M50GC	12	24	Included	Y	22,000 A	#6-2/0	6	Both
60	CHOM1224M60GC	12	24	Included	Y	22,000 A	#6-2/0	6	Both
	CHOM1632M60GC	16	32	Included	Y	22,000 A	#6-2/0	7	Both
70	CHOM1224M70GC	12	24	Included	Y	22,000 A	#6-2/0	6	Both
	CHOM1632M70GC	16	32	Included	Y	22,000 A	#6-2/0	7	Both
100	CHOM1224M100GC	12	24	Included	Y	22,000 A	#6-2/0	6	Both
	CHOM1632M100GC	16	32	Included	Y	22,000 A	#6-2/0	7	Both
	CHOM2448M100GC	24	48	Included	Y	22,000 A	#6-2/0	8	Both
	CHOM3060M100GC	30	60	Included	Y	22,000 A	#6-2/0	10	Both
125	CHOM1224M125GC	12	24	Included	Y	22,000 A	#6-2/0	6	Both
	CHOM1632M125GC	16	32	Included	Y	22,000 A	#6-2/0	8	Both
	CHOM2448M125GC	24	48	Included	Y	22,000 A	#6-2/0	8	Both
	CHOM3060M125GC	30	60	Included	Y	22,000 A	#6-2/0	10	Both

Factory-Installed Main Circuit Breaker

100	CHOM3060M2100GC	30	60	Included	Y	22,000 A	#4-250	10	Both
	CHOM4284M2100GC	42	84	Included	Y	22,000 A	#4-250	12	Both
	CHOM60120M2100GC	60	120	Included k	Y	22,000 A	#4-250	24	Both
150	CHOM2040M150GC	20	40	Included	Y	22,000 A	#4-250	9	Both
	CHOM3060M150GC	30	60	Included	Y	22,000 A	#4-250	10	Both
	CHOM60120M150GC	60	120	Included k	Y	22,000 A	#4-250	24	Both
200	CHOM2040M200GC	20	40	Included	Y	22,000 A	#4-250	9	Both
	CHOM3060M200GC	30	60	Included	Y	22,000 A	#4-250	10	Both
	CHOM4284M200GC	42	84	Included	Y	22,000 A	#4-250	12	Both
	CHOM60120M200GC	60	120	Included k	Y	22,000 A	#4-250	24	Both

k Does not include a door. Order kit # CHOMDK602.

- Main Breaker loadcentres are approved for service entrance use. The main breaker compartment can be sealed and the main breaker can be locked.

- All type 1 loadcentres are approved for vertical, horizontal, or inverted mounting.

- Canadian HomeLine loadcentres 8/16-space and above (double-row construction) come with Plug-on Neutral capability as standard.

Canadian HomeLine™ Circuit Breakers and Loadcentres Type 3R Loadcentres and Type 1 Generator Panels

DE1 LOAD CENTRES

Single-Phase, Three-Wire, 120/240 Vac Main Lugs – Rainproof

Mains Rating in Amps	Loadcentre Catalogue Number	Maximum Number of Circuits		Loadcentre Cover Catalogue Number	Service Entrance Approved	Maximum Short Circuit Rating	Main Wire Size AWG/kcmil Al/Cu	Enclosure No. (Pages 34-35)	Top or Bottom Mains Position
		Standard 1"	Tandem or Quad						

Factory-Installed Main Lugs

70	CHOM24L70RB	2	4	Included	N	10,000 A	#12-3 Al #14-4 Cu	1R	Top
100	CHOM612L100RB	6	12	Included	N	10,000 A	#8-1	2R	Top
125	CHOM48L125GRB	4	8	Included	N	10,000 A	#12-2/0 Al #14-2/0 Cu	15R	Top

Factory-Installed Main Lugs

125	CHOM816L125GRB	8	16	Included	N	10,000 A	#6-2/0	3R	Top
	CHOM1224L125GRB	12	24	Included	N	10,000 A	#6-2/0	3R	Top

Single-Phase Three Wire 120/240 Vac Main Breaker – Rainproof

Factory-Installed Main Circuit Breaker

100	CHOM816M100GRB	8	16	Included	Y	22,000 A	#6-1	3R	Top
	CHOM1224M100GRB	12	24	Included	Y	22,000 A	#6-2/0	3R	Top

Factory-Installed Main Circuit Breaker

200	CHOM2040M200GRB	20	40	Included	Y	22,000 A	#4-250	6R	Top
-----	-----------------	----	----	----------	---	----------	--------	----	-----

Single-Phase, Three-Wire, 120/240 Vac Generator Panels - Indoor

Homeline® Generator Panel (1Ø - 3w)

Mains Ampere Rating	Loadcentre Catalogue Number	Total Number of Circuits		Number of Circuits available for (generator) critical loads		Main Wire Size (AWG/MCM)	Box size (see page 34)
		Standard	Tandem or Quad	Standard	Tandem or Quad		
30	CHGP3038			20	38	#14-8	7
60	CHGP6038			20	38	#8-2	7

Homeline® 'all-in-one' SE Generator Panels

200	CHGP605638200	48	94	20	38	#4-250	24
150	CHGP605638150	48	94	20	38	#4-250	24
125	CHGP605638125	48	94	20	38	#4-250	24
100	CHGP605638100	48	94	20	38	#4-250	24

- Canadian HomeLine loadcentres 8/16-space and above (double-row construction) come with Plug-on Neutral capability as standard.

Fusible Loadcentre Inserts



Step #1
Identify Box Dimensions and Catalogue Number

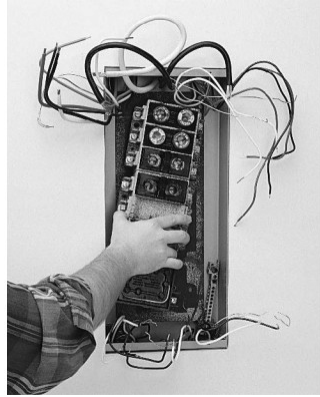

Step #2
Remove Old Fusible Interior



Step #3
Install New HFLCI



Step #4
Complete Installation

- HomeLine Fusible Loadcentre Inserts (HFLCI) offer the safety and reliability of a modern circuit breaker loadcentre system featuring HomeLine circuit breakers.
- Easily replaces outdated fusible loadcentres.
- Eliminates drywall removal and repair.
- Eliminates painting new drywall.
- No holes to drill.
- No new ground required.
- No branch conductors or conduit to remove.
- Using the HomeLine FLCI substantially reduces installation time, as much as 80%, allowing for the economical replacement of old fusible loadcentres.

Canadian HomeLine™ Circuit Breakers and Loadcentres Loadcentres

TM

DE1 LOAD CENTRES

HomeLine Fusible Loadcentre Inserts (HFLCI)

READ THIS FIRST!

To select the proper HFLCI, follow these three steps:

Step 1: Find your fusible loadcentre catalogue number using columns 1 and 2.

Step 2: Confirm that the original fusible loadcentre box dimensions match those in columns 5, 6, and 7.

Step 3: Use column 3 to identify the HomeLine Fusible Loadcentre Insert (HFLCI) catalogue number.

CAUTION: Do not proceed with an installation unless both the existing catalogue number and box dimensions match.

1	2	3	4		5		6		7	
Original Manufacturer	Original Main Lug Loadcentre Catalogue Number	HomeLine Catalogue Number**	Maximum Number of Circuits		Box Dimensions					
			Standard 1"	Tandem or Quad	Height		Width		Depth	
		Inches			mm	Inches	mm	Inches	mm	
Amalgamated Electric	4208	HFLCI12D	6	12	16.126	410	8.506	216	2.813	72
Amalgamated Electric	4212	HFLCI16D	8	16	19.506	496	8.506	216	2.813	72
Amalgamated Electric	4220	HFLCI20AD	10	20	24.256	616	8.506	216	2.813	72
Amalgamated Electric	4220	HFLCI24AD	12	24	24.256	616	8.506	216	2.813	72
Amalgamated Electric	4216	HFLCI20BD	10	20	23.126	587	8.506	216	2.813	72
Amalgamated Electric	4216	HFLCI24BD	12	24	23.126	587	8.506	216	2.813	72
Amalgamated Electric	4312	HFLCI20BD	10	20	23.126	587	8.506	216	2.813	72
Amalgamated Electric	4312	HFLCI24BD	12	24	23.126	587	8.506	216	2.813	72
CEB	NHP10-634	HFLCIC16BD	8	16	20.126	511	7.876	200	3.063	78
CEB	NHP10-636-3	HFLCIC20BD	10	20	24.126	613	10.126	257	3.063	78
CEB	NHP10-636-3	HFLCIC20ED	10	20	27.876	708	10.251	261	3.063	78
CEB	NHP10-636-3	HFLCIC24BD	12	24	24.126	613	10.126	257	3.063	78
CEB	NHP12-60	HFLCIC12DD	6	12	20.126	511	7.876	200	3.063	78
CEB	NHP12-633	HFLCIC20AD	10	20	23.126	587	7.876	200	3.063	78
CEB	NHP12-633	HFLCIC24AD	12	24	23.126	587	7.876	200	3.063	78
CEB	NHP4-632	HFLCIC12BD	6	12	16.256	413	7.876	200	3.063	78
CEB	NHP4-632-1	HFLCIC16D	8	16	19.126	486	7.876	200	3.063	78
CEB	NHP4-633-1	HFLCIC16D	8	16	19.126	486	7.876	200	3.063	78
CEB	NHP6-60	HFLCIC12CD	6	12	13.876	353	7.876	200	3.063	78
CEB	NHP6-633-1	HFLCIC16BD	8	16	20.126	511	7.876	200	3.063	78
CEB	NHP6-636-4	HFLCIC16CD	8	16	24.126	613	7.876	200	3.063	78
CEB	NHP8-60	HFLCIC12D	6	12	16.256	413	7.876	200	3.063	78
CEB	NHP8-635-2	HFLCIC20AD	10	20	23.126	587	7.876	200	3.063	78
CEB	NHP8-635-2	HFLCIC24AD	12	24	23.126	587	7.876	200	3.063	78
Taylor (Crouse Hinds)	NHP0020	HFLCIT8AD	4	8	12.876	327	9.626	245	3.063	78
Taylor (Crouse Hinds)	NHP6-30-60	HFLCIT16AD	8	16	21.126	537	7.506	191	3.063	78
Taylor (Crouse Hinds)	NHP1231	HFLCIT20AD	10	20	24.626	626	9.626	245	3.063	78
Taylor (Crouse Hinds)	NHP20-0821-6	HFLCIT20AD	10	20	24.626	626	9.626	245	3.063	78

** HomeLine FLCI's include distribution section interior, trim, door and painted architectural white.

Note: Not suitable for use with Canadian HomeLine AFI, CAFI, DF or GFI devices.

Accessories

- Plug-in surge breaker
- Ground bars
- Neutral lugs
- Filler plates
- Type 3R rain hubs
- Type 3R coupling trough
- Door lock
- Main lugs
- Replacement covers
- Replacement interiors



RB Hub



BC200 Enclosure Coupling



CHOM2175SB



CHOM250PSPD



PK15GTA



PK6FL



LK100AN

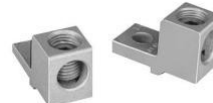

QOL125



HOMFP



QOM1FP



QOL225



QOM2FP

Canadian HomeLine™ Circuit Breakers and Loadcentres HomeLine Loadcentre Accessories

Replacement Covers, 1 Phase, Type 1 Enclosures ONLY

Reference Loadcentre Catalogue Number	Replacement Cover Catalogue Number
CHOM24L70S *	4055800801
CHOM24L70RB	4056314401
CHOM24L70F *	4055800701
CHOM48L125GC	4055844801
CHOM48L125GRB	4056318650
CHOM612L100S *	4055801702
CHOM612L100F *	4055801801
CHOM612L100RB	4056318550
CHOM816M100GRB	4056319050
CHOM1224M100GRB	4056319050
CHOM2040M200GRB	4056319150
CHOM 8-16,12-24 ML-MB loadcentres	CHOMC12UC
CHOM 16-32 60-100A MB loadcentres	CHOMC21UC
CHOM 16-32 125A, 24-48 ML-MB loadcentres	CHOMC24UC
CHOM 30-60 100-125A MB loadcentres	CHOMC30U125C
CHOM 30-60 150-225A ML-MB loadcentres	CHOMC30UC
CHOM 42-84 ML-MB loadcentres	CHOMC42UC
CHOM 20-40 MB loadcentres	CHOMC20UC

* No door on cover.

Door Lock Kits, 1 Phase, Type 1 Enclosures ONLY

Catalogue Number	Description
PK6FL	For use with type 1 Canadian HomeLine Loadcentres.

Surge Protective Device

Description	Catalogue Number
Plug-on Neutral CHOM Surge Protective Device for 1PH3W system 150Vac Maximum phase-to-ground	CHOM250PSPD
CHOM Surge Protective Device for 1PH3W system 15Vac maximum phase-to-ground	CHOM2175SB

Interchangeable Hubs

Conduit Size	Type B Hubs
Closing Plate	BCAP
3/4"	B075
1"	B100
1 1/4"	B125
1 1/2"	B150
2"	B200
2 1/2"	B250



B-150

Coupling Trough

Catalogue Number	Description
BC200	BC200 - enclosure coupling for RB devices

Filler Plates

Description	Catalogue Number
Branch Breaker	HOMFP
QOM1 Main Breaker	QOM1FP
QOM2 Main Breaker	QOM2FP

Optional Neutral Lugs

Wire Size	Catalogue Number
#12-2 AL #14-4 Cu	LK70AN
#6-2/0 AL/Cu	LK100AN
#14-2/0 AL/Cu	LK125AN
#2-3/0 Al/Cu	LK150AN

Main Lug Kits

Catalogue Number	Description
QOL125	125A Kit
QOL225	225A Kit

TECHNICAL INFORMATION

Grounding Bar Kits

instructions and an “Equipment Grounding Terminal” self-adhesive label.

All PK equipment grounding bar kits are supplied with mounting screws, necessary installation

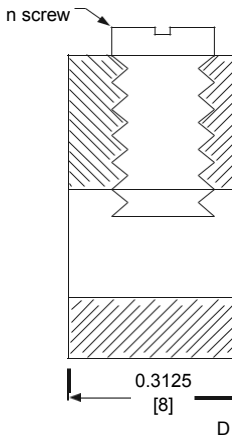

s Section of Size 1 Ground

Catalogue Number	Total Qty.	Terminals						Approximate Overall Length		Distance Between Mounting Holes		Mounting
		Quantity Each Size See “Wire Range Table” below.						in	[mm]	in	[mm]	
		I	II	III	IV	V	VI					
PK0GTA2	2	—	—	—	—	—	2	1.75	[44]	One hole	One hole	Top
PK0GTA6	6	—	—	—	—	6	—	4.61	[117]	1.69	[43]	Top
PK3GTA1	3	3	—	—	—	—	—	1.38	[35]	One hole	One hole	Top
PK4GTA	4	4	—	—	—	—	—	1.63	[41]	One hole	One hole	Top
PK5GTA	5	5	—	—	—	—	—	2.25	[57]	1.25	[32]	Top
PK7GTA	7	7	—	—	—	—	—	2.88	[73]	1.25	[32]	Top or Side
PK9GTA1	9	9	—	—	—	—	—	3.25	[83]	One hole	One hole	Top
PK9GTA	9	9	—	—	—	—	—	3.78	[96]	3.13	[80]	Top
PK12GTA	12	12	—	—	—	—	—	4.70	[119]	3.13	[80]	Top
PK15GTA	15	15	—	—	—	—	—	5.63	[143]	3.13	[80]	Top
PK15GTAL	16	15	1	—	—	—	—	8.13	[207]	3.13	[80]	Top
PK15GTA6 ¹	21	15	—	—	6	—	—	5.88	[149]	—	2	Top
PK18GTA	18	18	—	—	—	—	—	6.56	[167]	3.13	[80]	Top
PK18GTAL	19	18	1	—	—	—	—	8.81	[224]	3.13	[80]	Top
PK23GTA	23	23	—	—	—	—	—	8.11	[206]	3.13	[80]	Top
PK23GTAL	24	23	1	—	—	—	—	9.44	[240]	3.13	[80]	Top
PK27GTA ³	27 or 26	27 or 26	—	1	—	—	—	9.36	[238]	3.13	[80]	Top

- ¹ Mounting screws 21594-14241(two required) and 21594-17121(two required).
- ² 3.13 in. (80 mm) on small terminals; 5.25 in. (133 mm) on large terminals.
- ³ PK27GTA includes one main grounding lug that mounts with two terminal screws and requires three terminals for mounting.

Wire Range Table

Size	Cu (AWG)	Al (AWG)
I	(1) #14-#4 or (2) #14 or #12	(1) #12-#4 or (2) #12 or #10
II	(1) #1-4/0	(1) #1-4/0
III	(1) #6-2/0	(1) #6-2/0
IV	(1) #6-3/0	(1) #6-3/0
V	(1) #14-1/0	(1) #14-1/0
VI	(1) #10-2/0	(1) #6-2/0

Canadian HomeLine™ Circuit Breakers and Loadcentres Wiring Diagrams

WIRING DIAGRAMS

DE1 LOAD CENTRES



CHOM24L70S/F
CHOM24L70RB

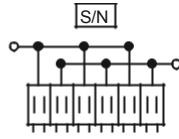

CHOM612L100S/F
CHOM612L100RB

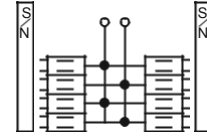

CHOM816L125GC
CHOM816L125GRB

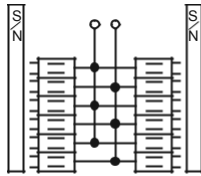

CHOM1224L125GC
CHOM1224L125GRB

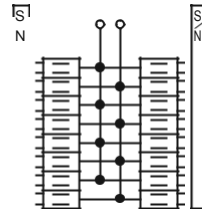

CHOM1632L125GC

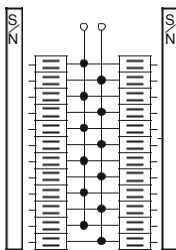

CHOM2448L125GC

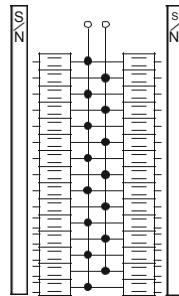

CHOM3060L225GC

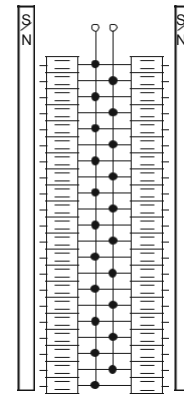

CHOM4284L225GC

Canadian HomeLine™ Circuit Breakers and Loadcentres Wiring Diagrams

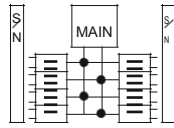

CHOM816M100RB

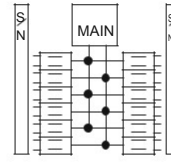

CHOM1224M100GC
CHOM1224M125GC
CHOM1224M100GR

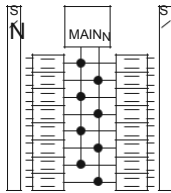

CHOM1632M100GC
CHOM1632M125GC

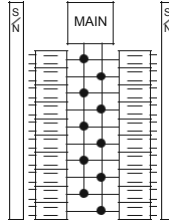

CHOM2040M150GC
CHOM2040M200GC
CHOM2040M200GR

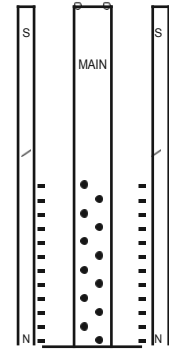

CHOM2448M100GC
CHOM2448M125GC

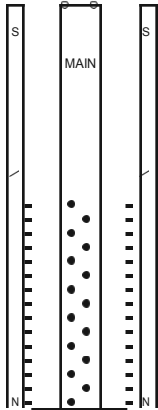

CHOM3060M100GC
CHOM3060M125GC
CHOM3060M150GC
CHOM3060M200GC
CHOM3060M2100GC

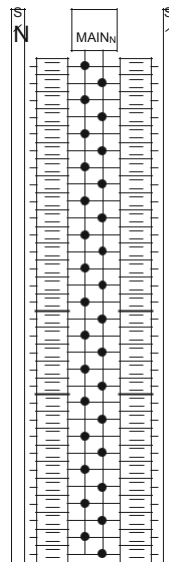

CHOM60120M200GC

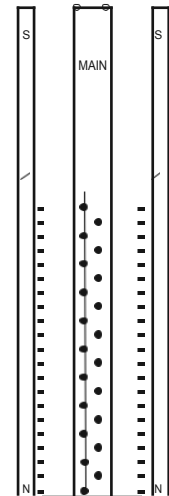

CHOM4284M200GC
CHOM4284M2100GC

1-Phase, 3-Wire Main Circuit Breakers

08/19

ctric

DE1-33

Canadian HomeLine™ Circuit Breakers and Loadcentres

Wiring Indoor Dimensions Diagrams and Knockouts

DE1 LOAD CENTRES

INDOOR DIMENSIONS AND KNOCKOUTS

Indoor Dimensions						
Box No.	W		H		D	
	in.	mm	in.	mm	in.	mm
2	4.81	122	9.30	236	3.19	81
4	8.88	226	12.57	319	3.80	97
6	14.25	362	17.92	455	3.75	95
7	14.25	362	20.92	531	3.75	95
8	14.25	362	26.04	661	3.75	95
9	14.25	362	29.86	758	3.75	95
10	14.25	362	33.78	858	3.75	95
12	14.25	362	39.37	1000	3.75	95
21	8.88	226	14.80	376	3.80	97
24*	14.25	362	48.50	1232	3.75	95

Knockouts									
Symbol	A	B	C	D	E	F	G	H	I
Conduit Size	0.50 in. 13 mm	0.75 in. 19 mm	1.00 in. 25 mm	1.25 in. 32 mm	1.50 in. 38 mm	2.00 in. 51 mm	2.50 in. 64 mm	3.00 in. 76 mm	3.50 in. 89 mm

* Note: Box 24 knockout drawing to follow.

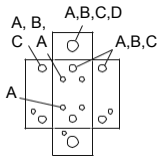

Box 2

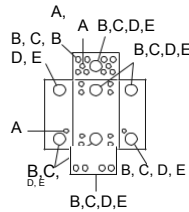

Box 4

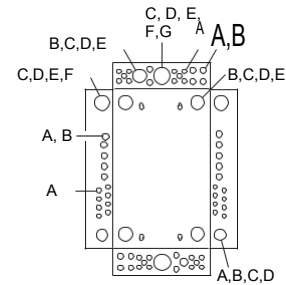

Box 7

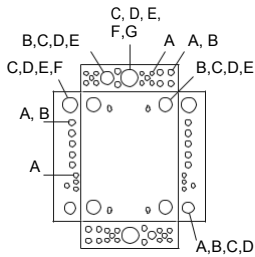

Box 6

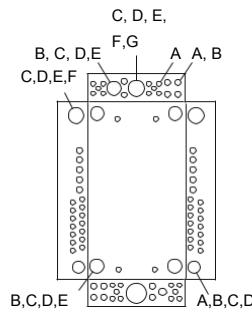

Box 8

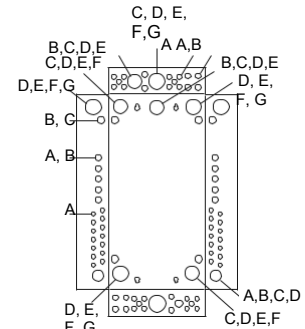

Box 9

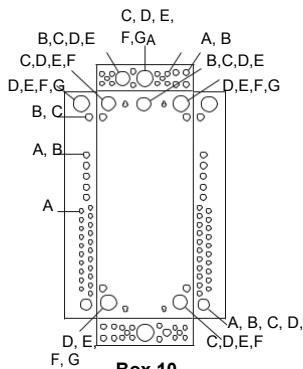

Box 10

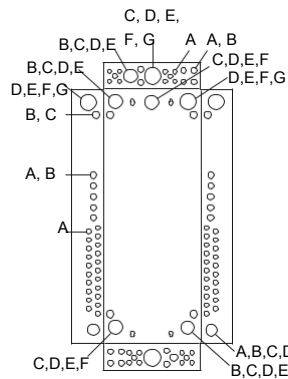

Box 12

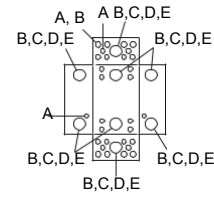

Box 21

OUTDOOR DIMENSIONS AND KNOCKOUTS

Outdoor Dimensions						
Box No.	W		H		D	
	in.	mm	in.	mm	in.	mm
1R ¹	4.88	124	9.38	238	4.00	102
2R	8.88	226	12.65	321	4.27	108
3R	14.75	375	18.92	481	4.52	115
6R	14.75	375	29.86	758	4.52	115
15R	8.88	226	14.80	376	4.27	108

¹ CHOME250SPA top endwall has no hub opening.

Knockouts								
Symbol	A	B	C	D	E	F	G	H
Conduit Size	0.50 in. 13 mm	0.75 in. 19 mm	1.00 in. 25 mm	1.25 in. 32 mm	1.50 in. 38 mm	2.00 in. 51 mm	2.50 in. 64 mm	3.00 in. 76 mm

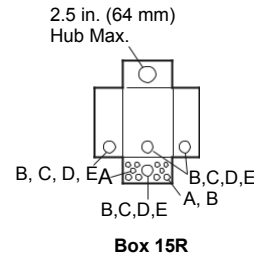
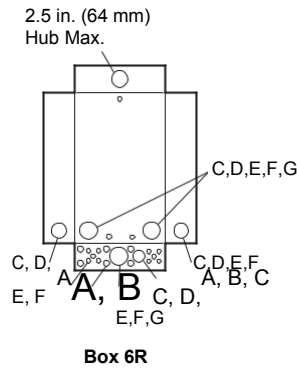
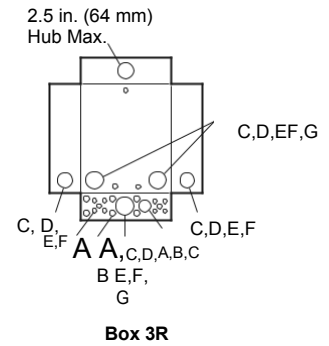
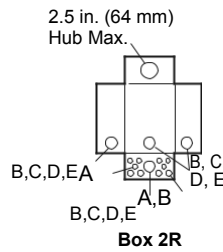
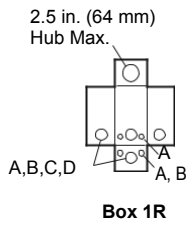

E.&O.E.

Intentionally left blank

Breaker Features:

- Type NC with Robertson/slot screws
- Type NC with colour coded handles
- Thermal magnetic trip protection
- Exclusive line side stab connection
- Trip free operation
- Calibrated at 40° C
- Availability of a wide range of GFCIs
- Arc resistant case

NC The Compact Stab-lok Breaker -
1/2" Wide per pole



NC015, NC0215, NC0230

Stab-lok Breaker Rating Table

Type	Poles	Amp Rating	Maximum Voltage	Interrupting Capacity
NC	1	15-50	120	10,000 A
	2	15-50	120/240	10,000 A
NA	1	15-50	120	10,000 A
	2	15-150	120/240	10,000 A
	3	15-100	240	10,000 A
1C	2	30-40	120/240	10,000 A
		50-125		22,000 A
2C	2	100-200	120/240	22,000 A

NA The Original Stab-lok Breaker - 1" Wide per pole



NA15



NA215



NA3P20



NA2P100

Stab-lok Circuit Breakers Circuit Breakers and Accessories

DE1 LOAD CENTRES

Standard and Main Circuit Breakers

Standard Loadcentre Breakers

Type	Amp Rating	1 Pole Cat. No.	List Price	Lug Range	2 Pole Cat. No.	List Price	Lug Range	3 Pole Cat. No.	List Price	Lug Range
NC	15	NC015		#14 - #6	NC0215		#14 - #6	—	—	—
	20	NC020			NC0220			—	—	
	25	NC025			NC0225			—	—	
	30	NC030			NC0230			—	—	
	40	NC040			NC0240			—	—	
	50	NC050		#14 - #4	NC0250		#14 - #4	—	—	
NA	15	NA15 ⁽²⁾		#14 - #2	NA215		#14 - #2	NA3P15		#14 - 1/0
	20	NA20 ⁽²⁾			NA220			NA3P20		
	25	NA25			NA225			—	—	
	30	NA30			NA230			NA3P30		
	35	NA35			—	—		—	—	
	40	NA40			NA240			NA3P40		
	50	NA50		NA250		NA3P50				
	60	—	—	NA260		NA3P60				
	70	—	—	NA270		NA3P70				
	90	—	—	NA2P90		NA3P90				
	100	—	—	NA2P100		NA3P100				
	125	—	—	NA2P125		—	—			
150	—	—	NA2P150 ¹		—	—				

Notes:

1. NA2P150 rated 150A when used with copper conductor only
2. Switching duty approved breakers. Breakers are marked SWD
3. 2-pole and 3-pole breakers greater than 70A take 4 and 6 NA breaker positions respectively
4. Use solid conductor only when #14 wire is used
5. *

Stab-lok Main Circuit Breakers

Type	Amp Rating	2 Pole Cat No.	List Price	Lug Range	3 Pole Cat No.	List Price	Lug Range
NA	30-100	—	—	—	Use Breaker Table Above		
1C	30	1C30		#4-2/0	—	—	—
	40	1C40			—	—	—
	50	1C50			—	—	—
	60	1C60			—	—	—
	70	1C70			—	—	—
	90	1C90			—	—	—
	100	1C100			—	—	—
2C	125	1C125		#4-250MCM	—	—	—
	100	2C100			—	—	—
	125	2C125			—	—	—
	150	2C150			—	—	—
	175	2C175			—	—	—
	200	2C200		—	—	—	



2C200

- * NC015/NC0215 Breaker Handle Colour - Blue
 NC020/NC0220 Breaker Handle Colour - Red
 NC030/NC0230 Breaker Handle Colour - Green
 NC040/NC0240 Breaker Handle Colour - Grey

Stab-lok Circuit Breakers

Stab-lok Breaker Accessories

Stab-lok Breaker Accessories

Breaker Type	Poles	Amp Rating	Handle Lock Off Non-Padlocking		Handle Lock Off Padlocking		Handle Tie	
			Cat. No.	List Price	Cat. No.	List Price	Cat. No.	List Price
NC	1	15-50	NCLOCK ⁽³⁾ / 1LOK ⁽²⁾	—	—	—	NCTIE ⁽¹⁾ / HTNC ⁽²⁾	—
	2	15-50	—	—	CLOCK (Not suitable for ribbed handles)	—	—	—
NA	1	15-50	1LOK	—	1LOB	—	HTNA (Not to be used for 2 pole applications)	—
	2	15-70	—	—	2LOK (2+3 pole modular)	—	—	—
	2	90 - 150	—	—	CLOCK	—	—	—
	3	Non - Modular	—	—	3100LOK	—	—	—
	3	Modular	—	—	2LOK	—	—	—

Note: Standard Packaging Size for all breaker accessories is 10

1. Suitable for ribbed handled NC breakers.
2. Suitable for square handled NC breakers.
3. Suitable for ribbed handled NC 1 + 2 pole breakers.

Stab-lok Circuit Breakers

Ground Fault Breakers

Stab-lok GFI with 5 mA Sensitivity (Class A)

Type	Amp Rating	1 Pole Cat. No.	List Price	2 Pole Cat. No.	List Price
NA	15	NAGF15		NAGF215	
	20	NAGF20		NAGF220	
	30	NAGF30		NAGF230	
	40	NAGF40		NAGF240	



NAGF15

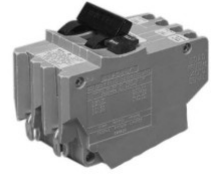

NAGF215

Stab-lok GFI with 33 mA Sensitivity

Type	Amp Rating	1 Pole Cat. No.	List Price	2 Pole Cat. No.	List Price
NA	15	NAGF1533		NAGF21533	
	20	NAGF2033		NAGF22033	
	30	NAGF3033		NAGF23033	
	40	NAGF4033		NAGF24033	

Stab-lok GFI with 10mA Sensitivity

Type	Amp Rating	2 Pole Cat. No.	List Price
NA	15	NAGF21510	
	20	NAGF22010	
	30	NAGF23010	
	40	NAGF24010	

Notes:

1. Submersible pump installations require ground fault protection to the maximum sensitivity level of 10mA. These breakers are designed to meet the Canadian Electrical Code under rule CEC 26-956
2. GFI breakers maximum 250 feet (one way) feeder length
3. Use solid conductor only when #14 wire is used

Stab-lok Circuit Breakers

Arc-Fault Circuit Interrupters and Stab-lok Generator Panel - Replacement Breakers

Stab-lok - Arc Fault Circuit Interrupters (10,000 AIR)

Ampere Rating	Poles 120Vac	Catalogue Number
15	1	NA15AFI
20	1	NA20AFI



Note: For replacement use or to add AFCI protection to a circuit exempt by the 2015 CEC. This product is not a Combination Arc Fault Interrupter as de-fined in the 2015 CEC and later editions.

Stab-lok Generator Panel - Replacement Breakers















Catalogue Number	Amp Rating	Main Breaker Type	List Price
NA3P30GEN	30	NA3P30 Amp Modular Breaker-Transfer Disconnect	
NA3P60GEN	60	NA3P60 Amp Modular Breaker-Transfer Disconnect	
NA3P70GEN	70	NA3P70 Amp Modular Breaker-Transfer Disconnect	

Stab-lok Circuit Breakers

Recreation Vehicle Park Power Centre - Receptacle Kits

DE1 LOAD CENTRES

Receptacle Kits

Description		Cat. No.
Receptacle Kits for RH102-4CHTS		
One 15A 125V duplex with break-off tabs for separate feed. (Eagle #4270B)		K1
One 30A 125V (Eagle #1263)		K3
Side blanking plate for RH102-4CHTS units.		RH1024CHTSBRC
Receptacle Kits for RH104-8CHTS		
One 15A 125V duplex with break-off tabs for separate feed. (Eagle #4270B)		RM15
Two 15A 125V duplex with break-off tabs for (Eagle #4270B)		RM1515
15A receptacle module kit 1-1 GFI 15A (Hubbell GFR5252)		RM15GFI
15A receptacle module kit 2-1 GFI 15A (Hubbell GFR5252)		RM1515GFI
20A receptacle module kit 2-1 GFI 20A (Leviton 8899)		RM2020GFIS
One 30A 125V (Eagle #1263)		RM30
One 50A 125/250V (Eagle #58)		RM50
One 30A 125V and one 15A 125V duplex with break-off tabs for separate feed (Eagle #1263 & #4270B)		RM1530
One 30A 125V and one 15A GFI receptacle (Hubbell GFR5252)		RM15GFI30
One 125V twist lock 20A (Hubbell #23CM10) 30A (Hubbell #26CM10)		RM20TL RM30TL
Side blanking plate for RH104-8CHTS using non-twist lock receptacle kits. Side blanking plate for RH104-8CHTS using twist lock receptacle kits.		RM00 RMBLTL

Stab-lok Loadcentres and Circuit Breakers Accessories

Stab-lok Loadcentre Accessories

Door Kits, 1 Phase, Type 1 Enclosures ONLY

Reference Loadcentre Catalogue Number	Door Kit Catalogue Number	List Price	Std. Package Size
108-16-125	DK1W98		3
112-24-125	DK2W98		
116-32-125	DK3W98		
120-40-125	DK4W98		
124-48-125	DK5W98		
132-64-225	DK8W98		
142-84-225	DK9W98		
BE108-16-1CXXX	DK1BEW98		
BE112-24-1CXXX	DK2BEW98		
BE116-32-1CXXX	DK3BEW98		
BE120-40-1CXXX	DK4BEW98		
BE124-48-1CXXX	DK5BEW98		
BE132-64-1CXXX	DK6BEW98		
BE120-40-2CXXX	DK7BEW98		
BE124-48-2CXXX	DK7BEW98		
BE132-64-2CXXX	DK8BEW98		
BE142-84-2CXXX	DK9BEW98		

Note: For use with W98 Series Stab-lok loadcentres.

Door Lock Kits, 1 Phase, Type 1 Enclosures ONLY

Catalogue Number	List Price	Description
PK6FL		For use with 125 and 225A W98 Series Stab-lok loadcentres.



DK3W98



PK6FL

Main Lug Kits

Max. Bus Rating (A)	Main Lug Kit Catalogue Number	List Price
125A	QOL125	
225A	QOL225	

Note: For use with W98 Series Stab-lok loadcentre interior. Single phase only.

Filler Plates

Catalogue Number	Description	List Price
PF1	Filler plate for NA or NC breakers. For use in present design of Stab-lok enclosures, except 400 A - see BFAB. Will also fit previous design using 1/2" metal KO's PF1 consists of 1 strip of 4 1/2" plastic fillers suitable for 4 NC poles or 2 NA poles. Minimum order quantity 25	
BFAB	Filler plate for 1 NA breaker. For use in present 400 A enclosure design and previous enclosure designs using aluminum center strip. Minimum order quantity: 50	



PF1



BFAB

Stab-lok Circuit Breakers

Stab-lok Loadcentre Accessories

DE1 LOAD CENTRES

Sub-Feed Kits, MLO Panels Only

Enclosure Cat. No.	Ordering Catalogue Number	List Price	Amp Rating (A)	Lug Range
10816125	SFL125W98*		125 A	#6-300MCM
11224125				
11632125				
12040125				
12448125				
31224 S/F	SFL100		100 A	#14-1/0
31836 S/F	SFL225		225 A	#6-300MCM
33060 S/F				
34284225 S/F				

* For use with 125A W98 Series Stab-lok Loadcentres.

* Sub-feed lugs for 225A W98 Series may be ordered as a factory installed option.

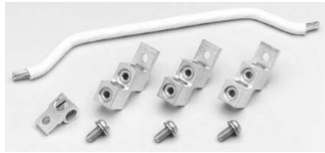

SFL100



GLK12

Ground Lug Kits

No. of Ccts	Ordering Catalogue Number	List Price	Lug Range
3	L79A253		#14 - #4
6	GLK6		
10	GLK10		
12	GLK12		

Neutral Lug Kits

Amp Rating	Ordering Catalogue Number	List Price	Lug Size
150	NLK150W98		#6 - 2/0

Note: Suitable for Cu/Al conductors.

Drip Proof Hoods EEMAC 2

Enclosure Cat. No.	Ordering Catalogue Number	Std. Package Size	List Price
1022S	R2	4	
1024S			
1048S			
31224S	R4	2	
31836S			
33060S			
34284225S			
	SDH	1	

Touch Up Paint

Description	Ordering Catalogue Number	List Price
Architectural White	ARCWHITE	